

JVC



DVD VIDEO RECORDER & VIDEO CASSETTE RECORDER

DR-MV5SE DR-MV5BE

FIRST
See
AUTO SET UP
on **PAGE 17**

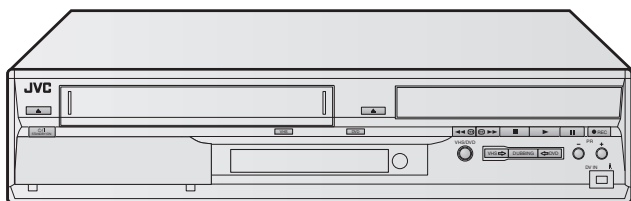

SHOWVIEW™

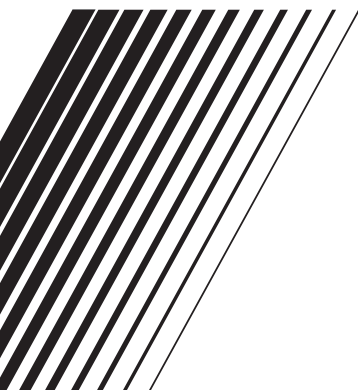

INSTRUCTIONS

LPT1092-001A

EN

Safety Precautions

The rating plate and the safety caution are on the rear of the unit.

WARNING: DANGEROUS VOLTAGE INSIDE

WARNING: TO PREVENT FIRE OR SHOCK HAZARD, DO NOT EXPOSE THIS UNIT TO RAIN OR MOISTURE.

CAUTION:

A UNIT IS A CLASS 1 LASER PRODUCT. HOWEVER THIS UNIT USES A VISIBLE LASER BEAM WHICH COULD CAUSE HAZARDOUS RADIATION EXPOSURE IF DIRECTED. BE SURE TO OPERATE THE UNIT CORRECTLY AS INSTRUCTED.

WHEN THIS UNIT IS PLUGGED INTO THE WALL OUTLET, DO NOT PLACE YOUR EYES CLOSE TO THE OPENING OF THE DISC TRAY AND OTHER OPENINGS TO LOOK INTO THE INSIDE OF THIS UNIT.

USE OF CONTROLS OR ADJUSTMENTS OR PERFORMANCE OF PROCEDURES OTHER THAN THOSE SPECIFIED HEREIN MAY RESULT IN HAZARDOUS RADIATION EXPOSURE.

DO NOT OPEN COVERS AND DO NOT REPAIR YOURSELF. REFER SERVICING TO QUALIFIED PERSONNEL.

CLASS 1 LASER PRODUCT

REPRODUCTION OF LABELS

WARNING LABEL INSIDE OF THE UNIT

CAUTION	VISIBLE AND INVISIBLE LASER RADIATION WHEN OPEN. AVOID EXPOSURE TO BEAM. DO NOT STARE INTO BEAM OR VIEW DIRECTLY WITH OPTICAL INSTRUMENTS.
ADVARSEL	SYNLIG OG USYNLIG LASERSTRÅLING VED ÅBNING. UNDGÅ UDSÆTTELSE FOR STRÅLING SE IKKE IND I STRÅLEN - HELLER IKKE MED OPTISKE INSTRUMENTER.
ADVARSEL	SYNLIG OG USYNLIG LASERSTRÅLING NÅR DEKSEL ÅPNES. UNDGÅ EKSPONERING FOR STRÅLEN STIRR IKKE INN I STRÅLEN ELLER SE DIREKTE MED OPTISKE INSTRUMENTER.
VARO!	AVATTAESSA OLET ALTTIINA NÄKYVÄÄ JA NÄKYMÄTÖN LASERSÄTEILYLLE. ÄLÄ TUJOTA SÄTEESEEN ÄLÄKÄ KATSO SITÄ OPTISEN LAITTEEN LÄPI.
VARNING	SYNLIG OCH OSYNLIG LASERSTRÅLNING NÅR DENNA DEL ÄR ÖPPNAD. STRÅLEN ÄR FARLIG STIRRA EJ IN I STRÅLEN OCH BETRAKTA EJ STRÅLEN MED OPTISKA INSTRUMENT.

IMPORTANT:

- Please read the various precautions on pages 2 and 3 before installing or operating the unit.
- It should be noted that it may be unlawful to re-record pre-recorded tapes, DVDs, or discs without the consent of the owner of copyright in the sound or video recording, broadcast or cable programme and in any literary, dramatic, musical, or artistic work embodied therein.

CAUTION:

- When you are not using the unit for a long period of time, it is recommended that you disconnect the power cord from the mains outlet.
- Dangerous voltage inside. Refer internal servicing to qualified service personnel. To prevent electric shock or fire hazard, remove the power cord from the mains outlet prior to connecting or disconnecting any signal lead or aerial.



- Manufactured under license from Dolby Laboratories. "Dolby" and double-D symbol are trademarks of Dolby Laboratories.
- "DTS" and "DTS Digital Out" are trademarks of Digital Theater Systems, Inc.
- Cassettes marked "VHS" (or "S-VHS") can be used with this unit. However, S-VHS recording is not possible with this model.
- This model is equipped with SQPB (S-VHS QUASI PLAYBACK) that makes it possible to play back S-VHS recordings in the SP mode with regular VHS resolution.
- HQ VHS is compatible with existing VHS equipment.
- SHOWVIEW is a trademark of Gemstar Development Corporation. The SHOWVIEW system is manufactured under licence from Gemstar Development Corporation.
- This product incorporates copyright protection technology that is protected by method claims of certain U.S. patents and other intellectual property rights owned by Macrovision Corporation and other rights owners. Use of this copyright protection technology must be authorised by Macrovision Corporation, and is intended for home and other limited viewing users only unless otherwise authorised by Macrovision Corporation. Reverse engineering or disassembly is prohibited.

For Italy:

"It is declared that this product, brand JVC, conforms to the Ministry Decree n. 548 of 28 Aug.'95 published in the Official Gazette of the Italian Republic n. 301 of 28 Dec.'95"

The STANDBY/ON /I button does not completely shut off mains power from the unit, but switches operating current on and off. "I" shows electrical power standby and "I" shows ON.

When the equipment is installed in a cabinet or a shelf, make sure that it has sufficient space on all sides to allow for ventilation (10 cm or more on both sides, on top and at the rear).

When discarding batteries, environmental problems must be considered and the local rules or laws governing the disposal of these batteries must be followed strictly.

Failure to heed the following precautions may result in damage to the unit, remote control or disc.

1. **DO NOT place the unit —**
 - in an environment prone to extreme temperatures or humidity.
 - in direct sunlight.
 - in a dusty environment.
 - in an environment where strong magnetic fields are generated.
 - on a surface that is unstable or subject to vibration.
2. **DO NOT block the unit's ventilation openings or holes.**
(If the ventilation openings or holes are blocked by a newspaper or cloth, etc., the heat may not be able to get out.)
3. **DO NOT place heavy objects on the unit or remote control.**
4. **DO NOT place anything which might spill on top of the unit or remote control.**
(If water or liquid is allowed to enter this equipment, fire or electric shock may be caused.)
5. **DO NOT expose the apparatus to dripping or splashing.**
6. **DO NOT use this equipment in a bathroom or places with water. Also DO NOT place any containers filled with water or liquids (such as cosmetics or medicines, flower vases, potted plants, cups, etc.) on top of this unit.**
7. **DO NOT place any naked flame sources, such as lighted candles, on the apparatus.**
8. **AVOID violent shocks to the unit during transport.**

MOISTURE CONDENSATION

Moisture in the air will condense on the unit when you move it from a cold place to a warm place, or under extremely humid conditions—just as water droplets form on the surface of a glass filled with cold liquid. In conditions where condensation may occur, disconnect the unit's power plug from the wall and keep it disconnected for a few hours to let the moisture dry, then turn on the unit.

ATTENTION:**To mobile phone users:**

Using a mobile phone in the vicinity of the unit may cause picture vibration on the TV screen or change the screen to a blue back display.

On placing the unit:

Some TVs or other appliances generate strong magnetic fields. Do not place such appliances on top of the unit as it may cause picture disturbance.

Information for Users on Disposal of Old Equipment [European Union]

This symbol indicates that the electrical and electronic equipment should not be disposed as general household waste at its end-of-life. Instead, the product should be handed over to the applicable collection point for the recycling of electrical and electronic equipment for proper treatment, recovery and recycling in accordance with your national legislation.

**Attention:**

This symbol is only valid in the European Union.

By disposing of this product correctly, you will help to conserve natural resources and will help prevent potential negative effects on the environment and human health which could otherwise be caused by inappropriate waste handling of this product. For more information about collection point and recycling of this product, please contact your local municipal office, your household waste disposal service or the shop where you purchased the product. Penalties may be applicable for incorrect disposal of this waste, in accordance with national legislation.

(Business users)

If you wish to dispose of this product, please visit our web page www.jvc-europe.com to obtain information about the take-back of the product.

[Other Countries outside the European Union]

If you wish to dispose of this product, please do so in accordance with applicable national legislation or other rules in your country for the treatment of old electrical and electronic equipment.

Enjoying your life with DVD

Beautiful images

Enjoy the vivid picture quality of
DVD recording/playback.



OH!!
Great!!

Easy dubbing

With the simple operation, you
can dub from DVD to tape or
tape to DVD.

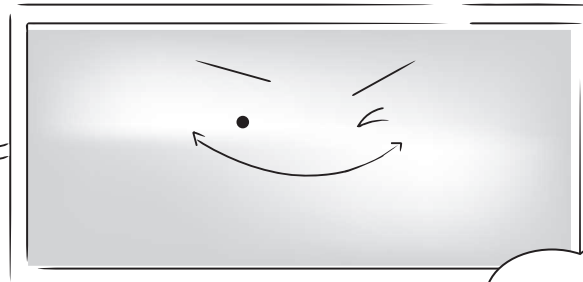
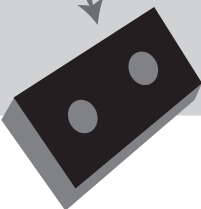

Bea



recorder

Choose the disc type for recording from DVD-RAM, DVD-RW and DVD-R.

3 types of DVD discs

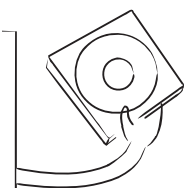

utiful!



Comfortable playback

Navigation function helps you to find the disc and programme you want to watch.

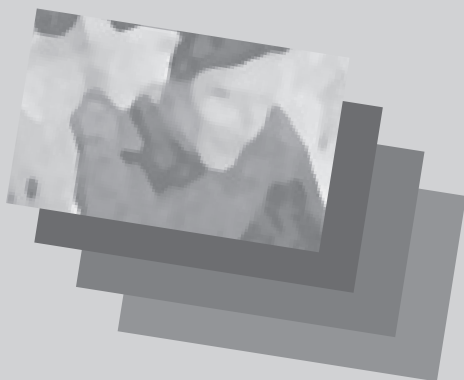

CONTENTS

Read me first!

For your safety	2
About discs	6
Index	10

Are you ready?

Get over it!	
- connections -	15
Initial settings	17

Let's enjoy...

Basic playback	24
Basic recording	26
Using timer	29
All over dubbing	37
Advanced playback	47
Advanced recording	61
What's navigation?	65

Arrange your style

1 remote control is good enough!	74
For better sound	76
It can be more useful	78





Need help?

Tips for your trouble	91
Terms	98

About Discs

Recordable/Playable Discs

You can use discs with the following logos for recording and playback.

	DVD-RAM 12 cm: 4.7 GB/9.4 GB 8 cm: 1.4 GB/2.8 GB Ver. 2.0/2x speed Ver. 2.1/1x – 2x speed
	DVD-RW 12 cm: 4.7 GB/9.4 GB Ver. 1.1/1x – 2x speed (Video mode/VR mode)
	
	DVD-R 12 cm: 4.7 GB 8 cm: 1.4 GB Ver. 2.0/1x – 4x speed (Video mode)

- The above table is based on the information as of April 2005.
- Recording and playback may not be performed depending on the characteristics and condition of the disc used, leading to unsatisfactory results. Using discs manufactured by JVC is recommended since they have been tested to be compatible with this unit.

DVD-RAM Discs

It is only possible to use discs which conform with DVD-RAM standard Version 2.0 or 2.1.

- It is impossible to record on DVD-RAM discs which do not conform to this standard. If you use a disc formatted under a different standard version, format it on this unit before use.
- It may not be possible to record, play back, edit or dub a DVD-RAM disc even if it conforms to the standard if it was recorded or edited on the devices from other manufacturers or on a PC, or if it has far too many titles, or if there is very little available capacity remaining on the disc.
- DVD-RAM discs recorded on this unit cannot be played back on an incompatible DVD player.
- It is possible to record copy-once programmes of digital broadcasts only onto 4.7/9.4 GB DVD-RAM discs (2.8 GB DVD-RAM discs are not compatible).

DVD-R/RW Discs

It is only possible to use DVD-R discs which conform with DVD-R standard Version 2.0.

When a DVD-R/RW disc (Video mode) is finalised (pg. 90), it can be played back on a standard DVD player as a DVD VIDEO disc.

When a DVD-RW disc (VR mode) is finalised (pg. 90), it can be played back on a standard DVD player compatible with the VR mode of DVD-RW discs.

Before finalising —

— it is possible to record on unrecorded areas of the disc, edit the disc title and programme titles, and delete programmes.

- It is impossible to record or edit DVD-R/RW discs recorded on other devices even if they have not been finalised.
- It is impossible to overwrite recorded areas of DVD-R discs.
- Available recording capacity does not increase even if a recorded programme is deleted from a DVD-R disc.

After finalising —

After a DVD-R/RW disc (Video mode) has been finalised, it is possible to play back the recorded programmes (video and/or audio) on a standard DVD video player as a DVD VIDEO disc.

- Edited titles are displayed as the “DVD menu” in video mode.
- It is impossible to record, edit or delete the data either in video mode or in VR mode.
- Either in video mode or in VR mode, although the disc can be played back on DVD players from other manufacturers, sometimes it may not be possible to play back depending on the disc and recording conditions.
- It is impossible to record on CD-R/RW or DVD-R discs used for authoring.
- It is impossible to record onto DVD-R/RW (Video mode) discs broadcasts that allow you to copy once. The copy-once programmes can only be recorded onto DVD-RW discs formatted in VR mode.

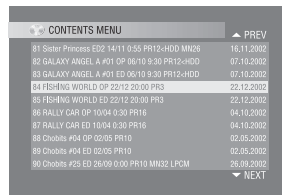







NOTE:

The following may result if you play back a DVD-R disc recorded on another unit.

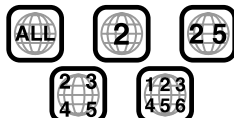
- The disc does not play.
- A mosaic pattern (block noise) appears on the screen.
- Video or audio may be dropped out.
- The unit stops during playback.

Discs For Playback Only

You can use discs with the following logos for playback only.

 DVD VIDEO (example of region code indications) 	DVD VIDEO	 COMPACT disc DIGITAL VIDEO	Video CD/Super Video CD
 COMPACT disc DIGITAL AUDIO	Audio CD CD-DA files	 COMPACT disc Recordable	CD-R CD-DA/JPEG/ MP3 files
 COMPACT disc ReWritable	CD-RW CD-DA/JPEG/ MP3 files	 COMPACT disc	CD-ROM JPEG/MP3 files

- Playback may not be performed depending on the characteristics and condition of the disc used.
- DTS Audio CDs can also be played back (An optional DTS decoder is required).
- MP3 and JPEG discs can be played back on this unit only when they have been recorded in the ISO9660 or Joliet format and finalised.
- JPEG files that can be played back on this unit must conform to JFIF/Baseline process, and the maximum resolution of a JPEG file is 2,812 x 2,112 pixels.
- CD-R/RW discs recorded in music CD format need to be finalised to play back on this unit.
- Operation and audio quality of this unit are not guaranteed for discs that do not conform to the Compact Disc specification (CD-DA). Before you play back a CD, check for the CD logo and read the notes on the package to confirm that it conforms to the Compact Disc specification.
- Depending on the intentions of the author of the software, recording conditions of DVD discs and Video CD discs may be restricted. Since this unit plays back discs according to the intentions of the author of the software as indicated on the disc, some functions may not operate as commanded.
- When switching from the first layer to the second layer of double-layered DVD VIDEO discs, the image and sound may be momentarily distorted. This is not a malfunction.

- DVD-AUDIO discs compatible with DVD video players can be played.
- Super Audio CDs (SACD) compatible with conventional CD players can be played.
- It is possible to play back finalised +R/+RW (Video mode only) discs. "DVD" lights on the front display panel when a +R/+RW disc is loaded.
However, the use of +R double layer disc on this unit may not be recommended.

Unplayable Discs

The following types of discs cannot be played using this unit. Do not attempt to play back any kind of disc that is damaged (cracked, warped, or repaired with adhesive tape) or discs in unusual shapes (heart-shaped, octagonal, or other forms). If such discs are accidentally played back, it may cause noise that can lead to speaker damage.

- CD-ROM discs (including PHOTO-CD and CD-G)
- Discs recorded in Packet Write (UDF) format
- 1.3-GB double density CDs (DDCD)
- High density CDs (HDCCD)

The following discs also cannot be played back.

- Discs of a region number other than "2"
- DVD-RAM (2.6 GB/5.2 GB)
- DVD-RAM (TYPE1)

Caution for DualDisc playback

The Non-DVD side of a "DualDisc" does not comply with the "Compact Disc Digital Audio" standard. Therefore, the use of Non-DVD side of a DualDisc on this product may not be recommended.

Region Number

The world is divided into 6 regions for DVD VIDEO discs. DVD VIDEO discs are assigned a region number to indicate which region they may be played back in. A disc cannot be played back on this unit unless the region number of the disc matches that of the unit. The region number for this unit is "2". Only discs whose region number includes "2" or "ALL" can be played back such as shown below.

Examples of DVD VIDEO labels which can be played back using this unit.



Marks of discs in this instruction manual

	Allows operation with a DVD-RAM disc.		Allows operation with a Video CD/Super Video CD (SVCD) disc.
	Allows operation with a DVD-R disc.		Allows operation with an Audio CD disc.
	Allows operation with a DVD-RW disc.		Allows operation with a disc including MP3 files.
	Allows operation with a DVD VIDEO disc.		Allows operation with a disc including JPEG files.

Recording Medium And Format

DVD-RAM

- Recording and erasing can be performed as many times as possible on a disc.
- Editing can be performed after recording, such as deleting unwanted parts.
- While recording, it is possible not only to start playback of a programme currently being recorded, but also to watch another programme previously recorded.

DVD-RW (VR mode)

- Recording and erasing can be performed as many times as possible on a disc.
- Editing can be performed after recording, such as deleting unwanted parts.

DVD-RW (Video mode)

- Can be played back on other DVD players after finalising.
- New recording can be performed by erasing all the data on a disc once played back.

DVD-R

- Can be played back on other DVD players after finalising.
- Suitable when keeping a recorded disc for a long time.

File Structure Of Discs

DVD VIDEO

Typically, DVD VIDEO discs are made up of larger units called "titles". Each title has a number (title number) that can be used to select desired titles. Titles are further divided into units called "chapters". Each chapter has a number (chapter number) that can also be used to select desired chapters. Note that some discs are not divided into titles and chapters.

When you record a programme on a DVD-RAM/RW (VR mode) disc

A single recording session results in a single title (a single chapter). However, chapter marks are automatically inserted when recording is paused, or audio changes from monaural or bilingual to stereo due to commercial breaks, etc. It is also possible to insert chapter marks at desired locations during playback. (pg. 49)

When you record a programme on a DVD-R/RW (Video mode) disc

A single recording session results in a single title (a single chapter). However, chapter marks are automatically inserted when recording is paused, or audio changes due to commercial breaks, etc. It is also possible to insert chapter marks at desired locations during either recording or playback. Once the disc has been finalised, these chapter marks are deleted and new chapter marks are assigned automatically approximately every 5 minutes.

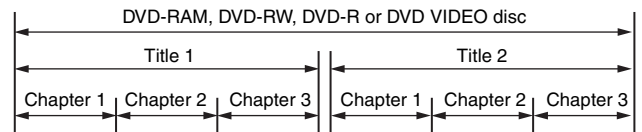

- In Video mode, even before finalising, it is impossible to perform editing operations other than changing the disc name and/or title names and deleting programmes and/or titles.
- After finalising, it is impossible to perform editing operations.

Audio CD/Video CD/Super Video CD (SVCD)

Typically, Audio CD discs are divided into separate tracks each containing one song. Each track is assigned a number. For example, the third track is Track 3. The same is true for Video CD discs.

However, some discs are not divided into tracks.

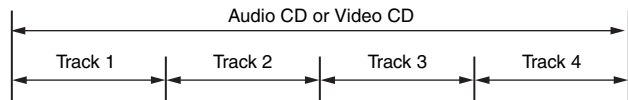

JPEG/MP3 Disc (CD-R/RW/ROM)

MP3/JPEG files put in directories nested in several levels on a disc will be organised as if they were put in single level directories (groups) by the MP3/JPEG Navigation of this unit. (pg. 72)

File structure of a disc before starting the MP3/JPEG Navigation

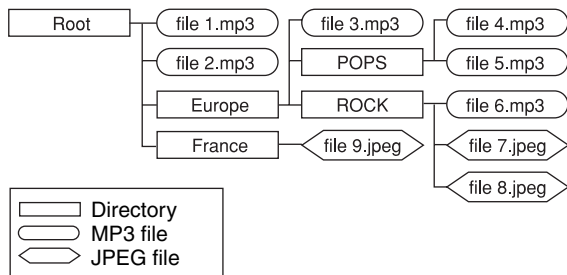

File structure of the disc after starting the MP3/JPEG Navigation

Files are automatically grouped as follows and displayed on the MP3/JPEG Navigation screen. Data is displayed in the alphabetical order of file name. Files are grouped based on roots.

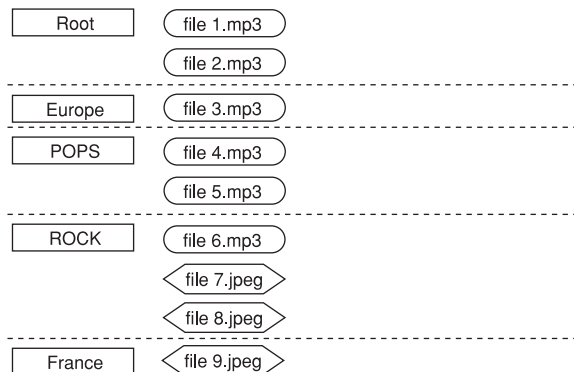

- This unit can recognise up to 9 hierarchies including directories and files. Also, it can recognise up to 250 files in each group, and up to 99 groups on a disc.

NOTES:

- **Video CD discs that support Playback Control (PBC)**
The contents of a disc are recorded into several hierarchies, and played back according to the instructions on the screen while navigating through the hierarchies. It is also possible to playback recorded tracks consecutively without activating the PBC function even when playing a PBC-compatible disc. (pg. 50)
- **Regarding the contents recorded on discs**
Some files may not be played back depending on the file types and other factors.

DVD VIDEO Marks

Sometimes marks are printed on a DVD disc and/or on its packaging to indicate information regarding the contents and functions of the disc. Check the marks indicating the contents and functions of the disc. Note, however, that in some cases a disc may not include a mark even for a function it supports.

Marks related to video

	Number of subtitles		Number of angles
	Recorded under the standard 4:3 aspect ratio		Screen includes black bands at the top and the bottom of image which has a standard 4:3 aspect ratio (letter box)
	Video playback is in Wide video mode (16:9) on wide televisions, but in letter box on televisions with standard 4:3 aspect ratio.		
	Video playback is in Wide video mode (16:9) on wide televisions, but pan and scan is used on televisions with standard 4:3 aspect ratio (either the left or right side of the image is cut-out).		

Marks related to audio

	Number of audio tracks
	Dolby Digital mark It has been developed by Dolby Laboratories as a digital surround system.
	DTS (Digital Theater Systems) You can enjoy DTS audio if you connect an amplifier with a built-in DTS decoder to the [DIGITAL AUDIO OUT] connector of the unit.

Placing A Disc

Opening the disc tray

Press **▲** (OPEN/CLOSE) to open the disc tray.

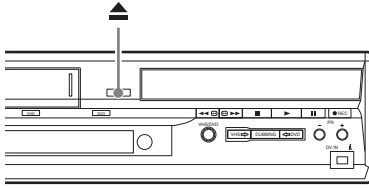

- Pressing the button again closes the disc tray.
- Use the button to open and close the disc tray.
- Do not block the disc tray with your hand while it is opening or closing as this may result in hardware failure.
- Do not place unplayable discs or any object other than a disc on the disc tray.
- Do not press down strongly on the disc tray or place any heavy objects on it.

Discs without cartridges

Place the disc on the disc tray with the label side facing up. Since disc size changes depending on the disc to be played back, be sure to correctly align the disc with the grooves for its size. If the disc is not in its groove, it may be scratched or otherwise damaged. To insert an 8 cm disc, place it according to the inner groove.

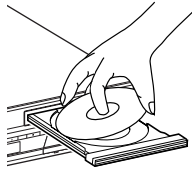

DVD-RAM discs contained in cartridges

Double-sided discs:

Remove the disc from the cartridge. Align the disc with the grooves on the disc tray as shown in the illustration and insert with the side you wish to play back or record facing down. If you insert the disc with "Side A" facing down, programmes are recorded on the side A.

Single-sided discs:

Remove the disc from the cartridge. Align the disc with the grooves on the disc tray as shown in the illustration and insert with the label side facing up.

Care And Handling Of Discs

How to handle discs

When handling a disc, do not touch the surface of the disc. Since discs are made of plastic, they are easily damaged. If a disc gets dirty, dusty, scratched or warped, the images and sound will not be picked up correctly, and such a disc may cause the unit to malfunction.

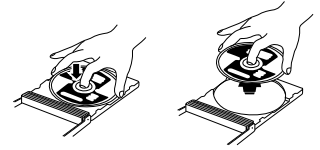

Label side

Do not damage the label side, stick paper to or use any adhesives on its surface.

Recording side

Make sure that discs are not scratched and dirty on the recording side before use. Scratches and dirt on the recording side of a disc may hinder proper playback and recording. Also be careful that a DVD-RAM disc may get scratched or dirt when removed from cartridge then put back in after use.

Storage

Make sure that discs are kept in their cases. If discs are piled on top of one another without their protective cases, they can be damaged. Do not put discs in a location where they may be exposed to direct sunlight, or in a place where the humidity or temperature is high. Avoid leaving discs in your car!

Maintenance of discs

If there are fingerprints or other dirt adhering to a disc, wipe with a soft dry cloth, moving from the centre outwards.

If a disc is difficult to clean, wipe with a cloth moistened with water. Never use record cleaners, petrol, alcohol or any anti-static agents.



CAUTION:

Sometimes during playback, noise may appear or images may be garbled. This is sometimes due to the disc. (It may not be up to industry standards.)

These symptoms are caused by the discs, not by the malfunction of the unit.

Front View

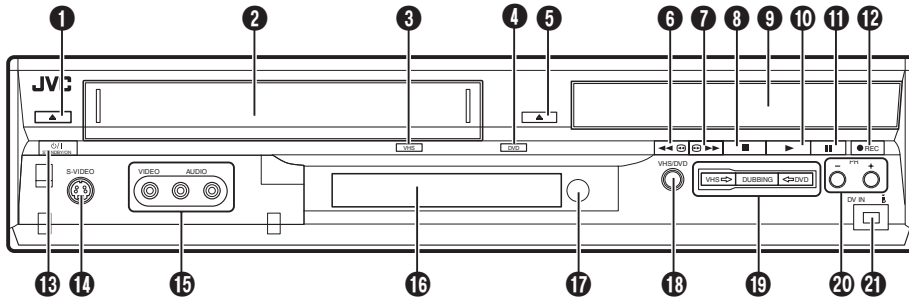

- 1 Eject Button (▲ (EJECT)) ↗ pg. 25
- 2 Cassette Loading Slot
- 3 VHS Lamp (VHS) ↗ pg. 25
- 4 DVD Lamp (DVD) ↗ pg. 24
- 5 Open/Close Button (▲ (OPEN/CLOSE)) ↗ pg. 9
- 6 Reverse Search Button (◀◀) (DVD deck) ↗ pg. 47, 54
Rewind Button (◀◀) (VHS deck) ↗ pg. 59
- 7 Forward Search Button (▶▶) (DVD deck) ↗ pg. 47, 54
Fast Forward Button (▶▶) (VHS deck) ↗ pg. 59
- 8 Stop Button (■) ↗ pg. 24, 25
- 9 Disc Tray
- 10 Play Button (▶) ↗ pg. 24, 25
- 11 Pause Button (||) ↗ pg. 24, 59
- 12 Record Button (●) ↗ pg. 26, 28
- 13 Standby/On Button (STANDBY/ON ⏻/⏻)
- 14 S-video Input Connector (S-VIDEO) (DVD deck only) ↗ pg. 42
- 15 Video/Audio Input Connectors (VIDEO/AUDIO ((MONO) L/R)) ↗ pg. 42
- 16 Front Display Panel ↗ pg. 14
- 17 Infrared Beam Receiving Window
- 18 VHS/DVD Select Button* (VHS/DVD) ↗ pg. 24, 25
* This button will not function during navigation mode or set up mode.
- 19 Dubbing Button (DUBBING) ↗ pg. 38 – 40
Dubbing Direction Buttons (VHS→/←DVD) ↗ pg. 37 – 40
- 20 Channel Buttons (PR +/-) ↗ pg. 26, 28, 41
- 21 DV Input connector (DV IN (i*)) (DVD deck only) ↗ pg. 41
* i (i.Link) refers to the IEEE1394-1995 industry specification and extensions thereof. The i logo is used for products compliant with the i.Link standard.

To access covered connectors, push and open the connector cover.

Rear View

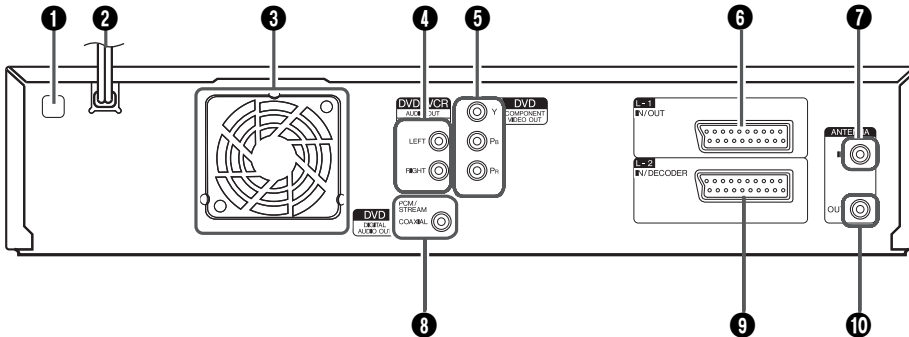

- 1 Region Number Label ↗ pg. 7
- 2 AC Power Cord ↗ pg. 15
- 3 Cooling Fan
 - This prevents the temperature from rising inside the unit. Do not remove it.
 - Install the unit so as not to block the area around the fan.
 - The cooling fan on the rear of the unit may be activated even if the unit is turned off in the following cases;
 - In the Automatic Satellite Programme Recording standby mode (↗ pg. 36), slightly before the starting time of VPS/PDC recording (↗ pg. 30)
 - If you connect the decoder or the satellite receiver to the [L-2 IN/DECODER] connector and if “L-2 SELECT” is set to “DECODER” or “SAT VIDEO/RGB”. (↗ pg. 44)
 - “JUST CLOCK” is set to “ON” (↗ pg. 88)
(Set “JUST CLOCK” to “OFF” if you mind the noise of the fan.)
- 4 Audio Output Connectors (AUDIO OUTPUT (LEFT/RIGHT)) ↗ pg. 16, 43
- 5 Component Video Output Connectors (COMPONENT VIDEO OUT) (DVD deck only) ↗ pg. 16
 - This component video output enables you to watch the images on the VHS deck in Progressive scan mode, refer to “VHS Progressive Scan” (↗ pg. 60).
- 6 L-1 Input/Output Connector (L-1 IN/OUT) ↗ pg. 15, 43, 76, 77
- 7 Antenna Input Connector (ANTENNA IN) ↗ pg. 15
- 8 Digital Audio Output Connector (DIGITAL AUDIO OUT (COAXIAL)) (DVD deck only) ↗ pg. 46, 77
- 9 L-2 Input/Decoder Connector (L-2 IN/DECODER) ↗ pg. 43, 76, 77
- 10 Antenna Output Connector (ANTENNA OUT) ↗ pg. 15

Remote Control

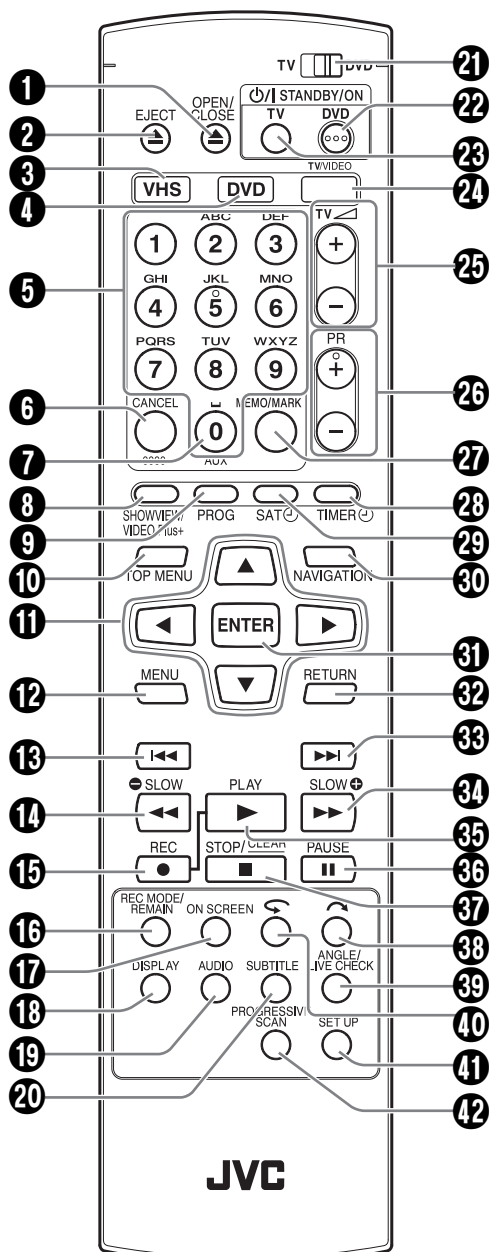

- 1 Open/Close Button (▲) (OPEN/CLOSE) ☞ pg. 9, 24
- 2 Eject Button (▲) (EJECT) ☞ pg. 25
- 3 VHS Button* ☞ pg. 25
* This button will not function during navigation mode or set up mode.
- 4 DVD Button* ☞ pg. 24
* This button will not function during navigation mode or set up mode.
- 5 Number Buttons ☞ pg. 26, 28, 29, 67
- 6 Cancel Button (CANCEL) ☞ pg. 58
Counter Reset Button (0000) ☞ pg. 63
- 7 Auxiliary Button (AUX)
- 8 SHOWVIEW Button ☞ pg. 29
- 9 Programming Button (PROG) ☞ pg. 31, 32, 34
- 10 Top Menu Button (TOP MENU) ☞ pg. 47
- 11 ▲▼◀▶ Buttons ☞ pg. 20
- 12 Menu Button (MENU) ☞ pg. 47
- 13 Reverse Skip Button (◀◀) ☞ pg. 47, 49, 54
Previous Button ☞ pg. 50

- 14 Reverse Search Button (◀◀) (DVD deck) ☞ pg. 47, 54
Rewind Button (◀◀) (VHS deck) ☞ pg. 59
Reverse Slow Button (SLOW -) ☞ pg. 48
- 15 Record Button (●) ☞ pg. 26, 28
- 16 Recording Mode Button (REC MODE) ☞ pg. 26, 28
Remain Button (REMAIN) ☞ pg. 49, 61
- 17 On-Screen Button (ON SCREEN) ☞ pg. 12, 13, 55
- 18 Display Button (DISPLAY) ☞ pg. 49, 61
- 19 Audio Button (AUDIO) ☞ pg. 50
- 20 Subtitle Button (SUBTITLE) ☞ pg. 49
- 21 TV/DVD Switch ☞ pg. 20
- 22 DVD Standby/On Button (DVD STANDBY/ON ⏻/⏻)
- 23 TV Standby/On Button (TV STANDBY/ON ⏻/⏻) ☞ pg. 75
- 24 TV/Video Input Button (TV/VIDEO) ☞ pg. 61, 63
- 25 TV Volume Buttons (TV ▲ +/▼ -) ☞ pg. 75
- 26 Channel Buttons (PR +/-) ☞ pg. 26, 28, 41
Page Buttons ☞ pg. 66, 70, 71
- 27 Memo Button (MEMO) ☞ pg. 66, 70
Mark Button (MARK) ☞ pg. 49
- 28 Timer Button (TIMER ⌚) ☞ pg. 29, 31, 32
- 29 Automatic Satellite Programme Recording Button (SAT ⌚) ☞ pg. 36
- 30 Navigation Button (NAVIGATION) ☞ pg. 65
- 31 Enter Button (ENTER) ☞ pg. 20
- 32 Return Button (RETURN) ☞ pg. 29, 57
- 33 Forward Skip Button (▶▶) ☞ pg. 47, 49, 54
Next Button ☞ pg. 50
- 34 Forward Search Button (▶▶) (DVD deck) ☞ pg. 47, 54
Fast Forward Button (▶▶) (VHS deck) ☞ pg. 59
Forward Slow Button (SLOW +) ☞ pg. 48
- 35 Play Button (▶) ☞ pg. 24, 25
- 36 Pause Button (⏸) ☞ pg. 24, 59
- 37 Stop Button (■) ☞ pg. 24, 25
Clear Button (CLEAR) ☞ pg. 58
- 38 Skip Search Button (↶) ☞ pg. 48, 54
- 39 Angle Button (ANGLE) (DVD deck only) ☞ pg. 49
Live Check Button (LIVE CHECK) ☞ pg. 54
- 40 One Touch Replay Button (↺) ☞ pg. 54
- 41 Set Up Button (SET UP) ☞ pg. 20
- 42 Progressive Scan Button (PROGRESSIVE SCAN) ☞ pg. 60, 80

How To Use

The remote control can operate most of your unit's functions, as well as basic functions of TV sets of JVC and other brands. (☞ pg. 74)

- Point the remote control toward the receiving window.
- The maximum operating distance of the remote control is about 8 m.

NOTES:

- When inserting the batteries, be sure to insert in the correct directions as indicated under the battery cover.
- If the remote control doesn't work properly, remove its batteries, wait for approximately 5 minutes, replace the batteries and then try operating the unit again.

On-Screen Display (DVD deck)

When "SUPERIMPOSE" is set to "AUTO" and **ON SCREEN** on the remote control is pressed, various operational indicators appear on the TV screen. To clear the operational indicators, press **ON SCREEN** twice.

When playing back a recorded title

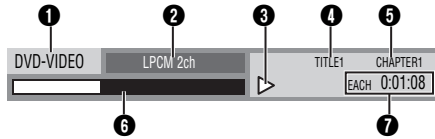

- 1 Disc type
- 2 Audio mode
- 3 Current status (playback)
- 4 Playback title number
- 5 Playback chapter number
- 6 Current playback point
- 7 Elapsed playing time

When recording

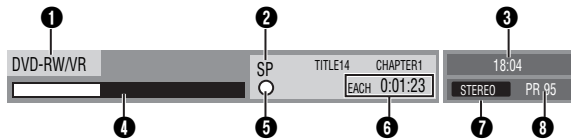

- 1 Disc type
- 2 Recording mode
- 3 Current time
- 4 Recording point
- 5 Current status (recording)
- 6 Elapsed recording time
- 7 Audio mode
- 8 Recording channel number

When pressing REC MODE

(Appears for eight seconds.)

	REC QUALITY	RECORDABLE TIME
XP	☆☆☆☆☆	1:00
SP	☆☆☆☆☆	2:00
LP	☆☆☆	4:01
EP	☆☆	6:03
FR	☆☆☆☆☆	2:31 (FR150)

- 1 Recording mode
- 2 Remaining disc time for each recording speed

During Instant Timer Recording (ITR)

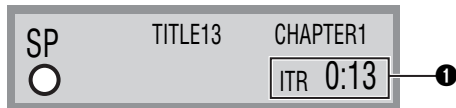

- 1 Record remaining time

When using Live Memory playback

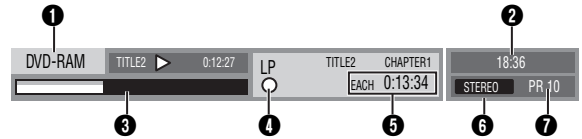

- 1 Disc type
- 2 Current time
- 3 Bar meter for recording/playback
- 4 Recording mode
- 5 Current playback time/Elapsed recording time
- 6 Audio mode
- 7 Recording channel number

DV Dubbing

When capturing images from the external DV equipment

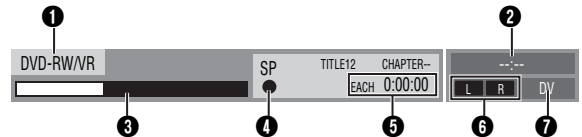

- 1 Disc type
- 2 Current time
- 3 Current recording point
- 4 Current status (recording)
- 5 Elapsed recording time
- 6 Sound mode
- 7 Recording channel (DV input)

DV Dubbing Controller

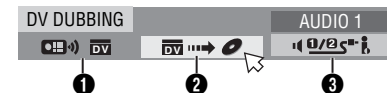

- 1 Displays when remote control is set to DV control mode.
- 2 Auto capture button
- 3 Sound monitor switch

On-Screen Display (VHS deck)

When "SUPERIMPOSE" is set to "AUTO" and **ON SCREEN** on the remote control is pressed, various operational indicators appear on the TV screen. To clear the operational indicators, press **ON SCREEN** twice.

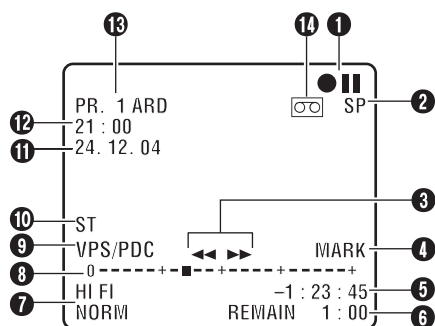

- ① Operation Mode Indicators
- ② Tape Speed (SP/LP)
- ③ Tape Direction
- ④ Index Mark Indicator (MARK) [↗ pg. 28](#)
- ⑤ Counter Display
- ⑥ Tape Remaining Time Indicator [↗ pg. 64](#)
- ⑦ Audio Mode Display [↗ pg. 60](#)

⑧ Tape Position Indicator

The tape position indicator appears on the TV screen when you press **◀** or **▶** from the Stop mode or perform an Index Search. ([↗ pg. 59](#)) The position of "I" in relation to "0" (beginning) or "+" (end) shows you where you are on the tape.

NOTE:

Depending on the type of tape being used, the tape position indicator may not appear correctly.

- ⑨ VPS/PDC Indicator [↗ pg. 30](#)
 - ⑩ Type of Broadcast [↗ pg. 64](#)
 - ⑪ Current Day/Month/Year
 - ⑫ Clock Display
 - ⑬ Channel Position Number and Station Name/Auxiliary Input Indicator (L-1, L-2, F-1 or SAT*)
- * When "L-2 SELECT" is set to "SAT VIDEO/RGB" ([↗ pg. 45](#)), "SAT" appears instead of "L-2".
- ⑭ "Cassette Loaded" Mark

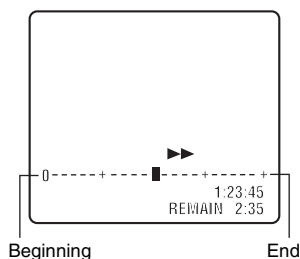

Front Display Panel

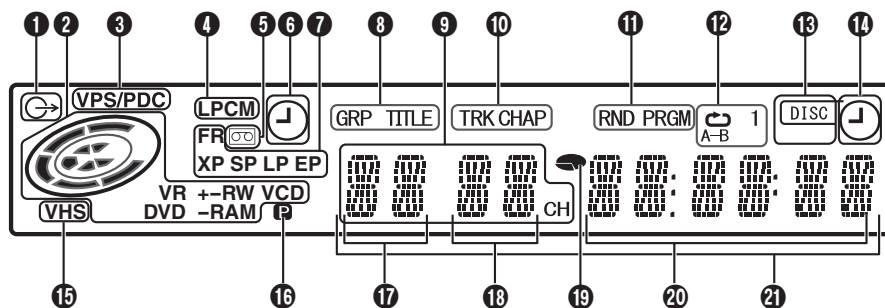
**1** Video Indicator (↻)

Lights when video mode is selected by pressing **TV/VIDEO**.

2 Disc Type Indicator

When a disc is loaded, the type of the disc is indicated.

Disc Status Indicator

When a disc is running, the disc marks rotate.

During High-Speed Search: Rotate faster than normal playback.
During Slow Motion: Rotate slower than normal playback.
While recording/dubbing: Inner red ring lights. During Timer Recording, inner red ring slowly blinks.

While playing back: Outside ring lights.

While paused: Disc marks blink when either recording or playing back.

While stopped: Disc marks all light.

While resume stopped: Disc marks all blink.

While the disc tray opened: Disc marks all light out.

No disc on the disc tray: Disc marks all light out.

VR Mode Indicator (VR) ⇨ pg. 7, 89

Lights when a DVD-RW disc is formatted in VR mode.

3 VPS/PDC Indicator ⇨ pg. 29 – 30**4** Linear PCM Indicator (LPCM)

Lights when "XP MODE REC AUDIO" is set to "LINEAR PCM" (⇨ pg. 79) for recording with DVD-RAM, DVD-R and DVD-RW discs, and when Linear PCM audio is played.

5 Cassette Loaded Mark (FR)

Indicates the present of a cassette in the VHS deck.

Lights when a cassette is loaded into the VHS deck. Blinks when the end of the tape has been reached during timer recording, or when the unit is in timer recording standby mode with a cassette without record safety tab inserted.

6 VHS Timer Indicator (⏸)

Lights when the VHS deck is in the timer recording standby mode or when timer recording is in progress.

Blinks rapidly when **TIMER** is pressed under the following conditions:

- Clock is not set.
- Timer programming has not been set.
- Cassette is not loaded.
- Timer recording standby mode with a cassette without safety tab inserted.
- Tape end is reached during time recording.

7 Recording Mode Indicator (XP/SP/LP/EP/FR) ⇨ pg. 27

Blinks when recording mode is being set.

While "FR" lights up, the left 3 digits of the Multi Display (17 18) indicate setting values ranging from "60" to "480". After the value has been set, only "FR" lights.

8 Group/Title Indicator (GRP/TITLE)

"GRP" or "TITLE" lights depending on a disc loaded while the left 2 digits of the Multi Display (17) indicate the numbers explained below.

"GRP": Total number of groups or group number being played back are displayed on the Multi Display.

"TITLE": Total number of titles or title number being played back are displayed on the Multi Display.

9 Channel/Recording Mode Indicator

Indicates the channel received. Or the recording mode (SP, LP) of the VHS deck. (⇨ pg. 28)

10 Track/Chapter Indicator (TRK/CHAP)

"TRK" or "CHAP" lights depending on a disc loaded while the 3rd and 4th digits from the left of the Multi Display (19) indicate the numbers explained below.

"TRK": Total number of tracks or track number being played back are displayed on the Multi Display.

"CHAP": Chapter number being played back are displayed on the Multi Display.

11 Random/Programme Playback Mode Indicator (RND/PRGM) ⇨ pg. 58

"RND": Lights when Random Playback mode is set.

"PRGM": Lights when Programme Playback mode is set.

12 Repeat Mode Indicator (1/A-B) ⇨ pg. 56

Select Repeat Playback mode on the on-screen bar.

"1": Whole disc is played back repeatedly.

"1": A single title/chapter/track is played back repeatedly.

"A-B": The selected part (A-B) is played back repeatedly.

No display: Repeat Playback mode is off.

13 DISC Indicator ⇨ pg. 32

Lights when a disc set up for On-Disc Timer Programming is loaded.

14 DVD Timer Indicator (⏸)

Lights when the DVD deck is in the timer recording standby mode or when timer recording is in progress.

Blinks when rapidly when **TIMER** is pressed under the following conditions:

- Clock is not set.
- Timer programming has not been set.
- Disc is not loaded.
- Timer recording standby mode with a non recordable disc.

15 VHS Indicator ⇨ pg. 25

Lights when VHS mode has been selected, during recording or when tapes recorded in VHS format are played back.

16 Video Output Indicator (P) ⇨ pg. 80

No display: Indicates that interlace mode is engaged.

P: Indicates that progressive mode is engaged.

(Example) P lights when video output mode is in progressive mode.

17 Group/Title Number Display**18** Track/Chapter Number Display**19** Remaining Time/Elapsed Time Indicator ⇨ pg. 49, 61

Lights when remaining time of DVD-RAM, DVD-R and DVD-RW discs is displayed, and lights out when elapsed time is displayed. The right 6 digits of the Multi Display (20) indicate elapsed or remaining time of each track.

No display: Indicates elapsed time of the disc.

Displayed: Indicates remaining time of the disc.

20 Remaining Time/Elapsed Time Display ⇨ pg. 49, 61**21** Multi Display

Displays clock, received channel, elapsed time, and remaining time. Also displays status of the unit (NO DISC/OPEN/CLOSE/READING).

Connections

It's essential that your unit be properly connected.

ATTENTION:

Your TV must have a 21-pin AV input connector (SCART) for the connection to the unit.

THESE STEPS MUST BE COMPLETED BEFORE ANY VIDEO OPERATION CAN BE PERFORMED.

- 1** Make sure the package contains all of the accessories listed in "SPECIFICATIONS" on page 95.
- 2** Place the unit on a stable, horizontal surface.
- 3** Connect the unit to a TV depending on the TV and cables you use.
 - (pg. 15, "Composite Connection")
 - (pg. 16, "Component Video Connection (DVD deck only)")

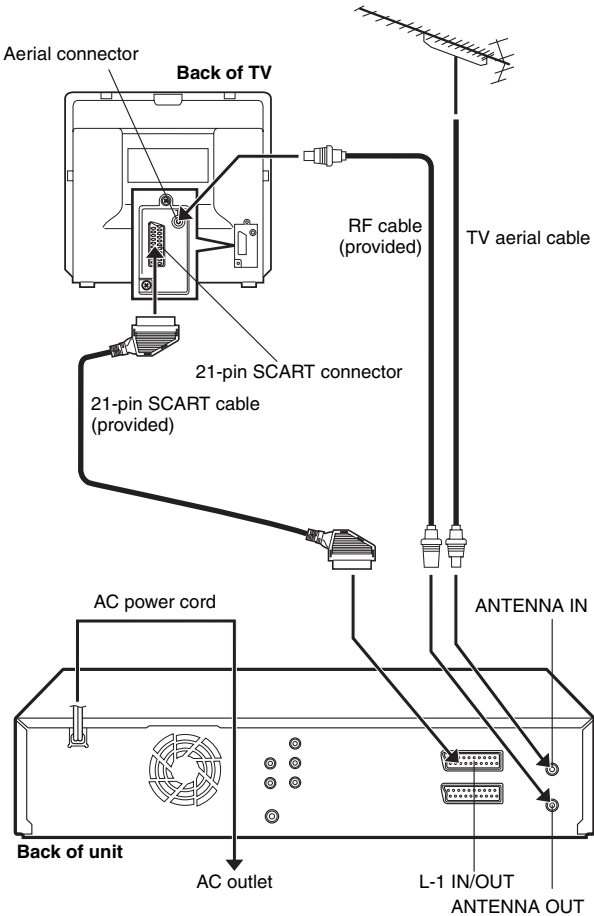

Composite Connection

- 1** Disconnect the TV aerial cable from the TV.
- 2** Connect the TV aerial cable to the [ANTENNA IN] connector on the rear panel of the unit.
- 3** Connect the [ANTENNA OUT] connector on the rear panel of the unit and the TV's aerial connector with the provided RF cable.
- 4** Connect the [L-1 IN/OUT] connector on the rear panel of the unit and the TV's 21-pin SCART connector with a provided 21-pin SCART cable.
 - The [L-1 IN/OUT] connector accepts and delivers either a composite signal (regular video signal), Y/C signal or RGB signal.
 - Set your TV to the VIDEO (or AV), Y/C, or RGB mode according to the type of your TV's SCART connector.
 - Select an appropriate option of "L-1 OUTPUT" as follows (pg. 44):

When your TV's SCART connector accepts:	Set "L-1 OUTPUT" to:
Composite video signals	"SCART VIDEO"
Y/C signal (separated luminance (brightness) and chrominance (colour) signals)	"SCART S-VIDEO"
RGB signal	"SCART RGB"

- 5** Plug the end of the AC power cord into an AC outlet.
 - "LOADING" blinks on the front display panel when the AC plug of the power cord is connected into a AC outlet and no operation will be done for approximately 50 seconds. This is not a malfunction.

After connection is completed, perform "Auto Set Up" on page 17.

Component Video Connection (DVD deck only)

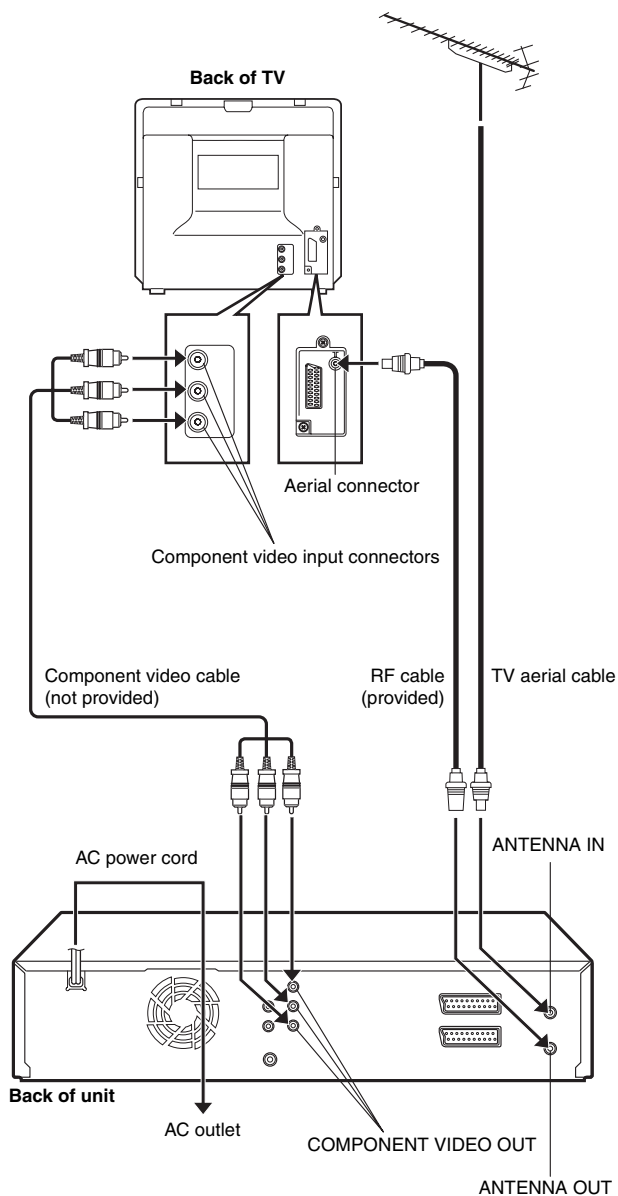
**ATTENTION:**

Your TV also must have a component video input connectors for the connection to the unit.

- 1** Perform **1** – **3** in “Composite Connection” (pg. 15).
- 2** Connect the unit's [COMPONENT VIDEO OUT] connectors to the TV's component video input connectors.
- 3** Connect the unit's [AUDIO OUT] connectors to the TV's AUDIO input connectors.
 - You can obtain high-quality component video pictures.
 - If your TV is not stereo-capable, use the unit's [AUDIO OUT] connectors to connect to an audio amplifier for Hi-Fi stereo sound reproduction.
 - By using the component video connection, you can view the images in the progressive mode. For switching to the progressive mode, refer to “Scan Mode Set” (pg. 80).
- 4** Plug the end of the AC power cord into an AC outlet.
 - “LOADING” blinks on the front display panel when the AC plug of the power cord is connected into an AC outlet and no operation will be done for approximately 50 seconds. This is not a malfunction.

After connection is completed, perform “Auto Set Up” on page 17.

Auto Set Up

Auto Channel Set/Auto Clock Set/Auto Guide Program Number Set

After the $\phi/1$ button on the unit or remote control is pressed for the first time to turn on the unit, by simply selecting your country*, the Auto Set Up function sets the tuner channels, clock** and Guide Program numbers automatically.

* If you live in Belgium (BELGIUM) or Switzerland (SUISSE), you also need to select your language.

** If you live in Hungary (MAGYARORSZÁG), Czech Republic (ČESKÁ REPUBLIKA), Poland (POLSKA) or other countries in Eastern Europe (OTHER EASTERN), set the clock manually.

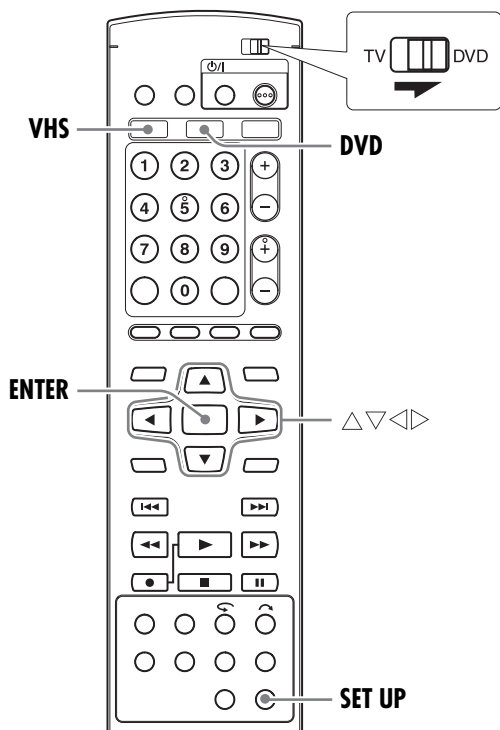

Before starting, make sure of the following:

- The TV aerial cable should be connected to the unit.
- The unit's AC power cord should be connected to a AC outlet.
- Turn on the TV and select the AV mode.
- Slide the TV/DVD switch to DVD.

1 Press $\phi/1$ to turn on the unit. The Country Set display appears on the TV screen.

2 Press $\Delta \nabla \triangleleft \triangleright$ to select your country's name, then press **ENTER**. The Language Set display appears on the TV screen.

NOTES:

- If you have selected BELGIUM or SUISSE, go to step 3.
- If you have selected MAGYARORSZÁG, ČESKÁ REPUBLIKA, POLSKA or OTHER EASTERN, press **ENTER**. The Clock Set screen appears. Set the clock manually (pg. 88), then go to step 4.
- If you have selected any other country name, go to step 4.

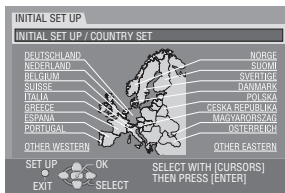

3 Press $\Delta \nabla \triangleleft \triangleright$ to select the language of your choice, then press **ENTER**. The AUTO SET/T-V LINK display appears on the TV screen.

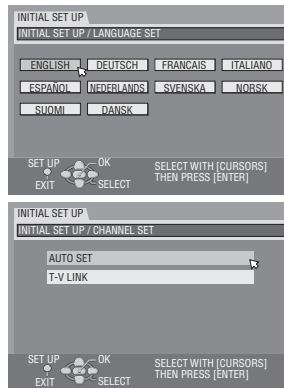

4 Press $\Delta \nabla$ to select "AUTO SET", then press **ENTER**. The AUTO SET screen will appear, and the unit automatically performs Auto Channel Set.

- When Auto Channel Set is completed, "PLEASE WAIT" will be displayed for about 90 seconds, since channel data is exchanged between the DVD deck and the VHS deck. No operation will be done during this time.

ATTENTION:

- When you have connected the unit to a TV offering T-V Link via a fully-wired 21-pin SCART cable (pg. 15) and the TV is turned on, the unit automatically performs the Preset Download (pg. 18) even if you select "AUTO SET" for Auto Set Up function.

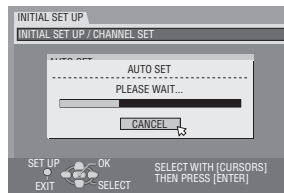

ATTENTION:

Once you have performed Auto Set Up, even if the unit's memory backup has expired, all the stored stations and their Guide Program numbers remain in the unit's memory and the unit will not perform Auto Set Up again. The unit only performs Auto Clock Set when the unit is turned on. If you have moved to a different area, perform each setting as required.

- Tuner setting (pg. 84)
- Clock setting (pg. 88)

If a new station starts broadcasting in your area, perform tuner setting. (pg. 84)

NOTES:

- In areas where no TV station transmits a PDC (Programme Delivery Control) signal, the unit can perform neither Auto Clock Set nor Auto Guide Program Number Set.
- If there is a power cut, or if you press $\phi/1$ or **SET UP** while Auto Set Up is in progress, Auto Set Up will be interrupted; be sure to turn off the unit power once and try again from step 1.
- Auto Clock Set may not function properly depending on the reception condition.
- If no sound accompanies the picture or the audio sounds unnatural on some channels that have been stored by Auto Set Up, the TV system setting for those channels may be incorrect. Select the appropriate TV system for those channels. (pg. 87, "INFORMATION")

After "Auto Set Up" is completed, perform "Monitor Set (DVD Deck Only)" on page 21.

Preset Download

Auto Channel Set By Downloading From TV/Auto Clock Set/Auto Guide Program Number Set

ATTENTION:

You can use this function only with a TV offering T-V Link, etc.* Be sure to use a fully-wired 21-pin SCART cable.

* Compatible with TVs offering T-V Link, EasyLink, Megalocic, SMARTLINK, Q-Link or DATA LOGIC via a fully-wired 21-pin SCART cable. The degree of compatibility and available functions may differ by system.

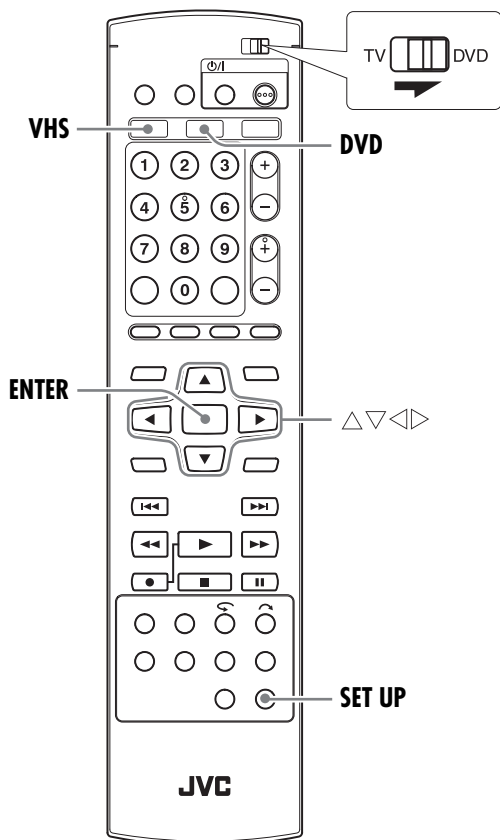

If you have connected the unit to your TV via a 21-pin SCART cable (☞ pg. 15), the unit will automatically perform Preset Download instead of the Auto Set Up in step 4 on page 17. After downloading, the unit sets the clock and Guide Program numbers automatically.

- Slide the TV/DVD switch to DVD.
- Perform steps 1 to 3 of "Auto Set Up" (☞ pg. 17) before continuing.

1 Press $\Delta \nabla$ to select "T-V LINK" and press **ENTER**. The T-V LINK screen will appear, and the unit automatically performs Auto Channel Set.

- When Auto Channel Set is completed, "PLEASE WAIT" will be displayed for about 90 seconds, since channel data is exchanged between the DVD deck and the VHS deck. No operation will be done during this time.

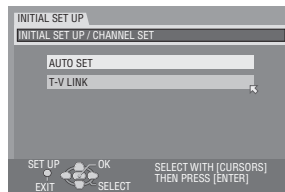

ATTENTION:

Preset positions on the front display panel increase from "PR 1"; do NOT press any button on the unit or remote control until the front display panel shows clock time, "PR 1" or "--:--" as illustrated on page 19.

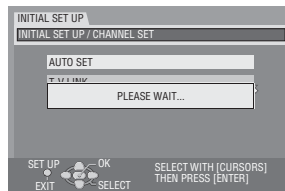

NOTES:

- For details, refer to the instruction manual of your TV.
- In the area where no TV station transmits a PDC (Programme Delivery Control) signal, the unit can perform neither Auto Clock Set nor Auto Guide Program Number Set.
- If there is a power cut, or if you press $\phi/1$ or **SET UP** while downloading or set up is in progress, it will be interrupted; be sure to turn off the unit power once and try again from the beginning.
- Auto Clock Set may not function properly depending on the reception condition.
- On this unit, the characters available for station names (ID) are A-Z, 0-9, -, *, + and _ (space). Some names of downloaded stations may differ from those of your TV. (☞ pg. 87)

After "Preset Download" is completed, perform "Monitor Set (DVD Deck Only)" on page 21.

Results Of Auto Set Up/Preset Download Appearing On The Front Display Panel

If both Auto Channel Set and Auto Clock Set have been performed successfully, the correct current time is displayed.

A PR 1 20:00

Turn on the TV and select its AV mode, then make sure that all necessary stations have been stored in the unit's memory by using the PR +/- button(s).

- If station names (ID – pg. 97) have also been stored in the unit's memory, the station name will be displayed at the top right corner of the TV screen for about 5 seconds when the unit is tuned to a different station.
- If you want to set the tuner manually such as to add or skip channels, to change channel positions, or to set or change station names, see pages 85 – 87.

If Auto Channel Set has succeeded but Auto Clock Set has not, "PR 1" (channel position) is displayed.

B PR 1 -:-:-

OR
If both Auto Channel Set and Auto Clock Set have failed, "-:-:-" is displayed.

1 Turn on the TV and select its AV mode, then make sure that all necessary stations have been stored in the unit's memory by using the PR +/- button(s).

- If station names (ID – pg. 97) have also been stored in the unit's memory, the station name will be displayed at the top right corner of the TV screen for about 5 seconds when the unit is tuned to a different station.
- If you want to set the tuner manually such as to add or skip channels, to change channel positions, or to set or change station names, see pages 85 – 87.

2 Perform "Clock Set" on page 88.

ATTENTION:

After making sure the cables are connected properly, turn off the unit's power once, then turn the unit's power back on again. The Country Set display appears on the TV screen; perform "Auto Set Up" on page 17 or "Preset Download" on page 18 again.

IMPORTANT:

- To check if the Guide Program numbers have been set correctly, perform the SHOWVIEW Timer Programming. (pg. 29)
- In certain reception conditions, station names may not be stored correctly, and auto Guide Program Number Set may not work properly. If the Guide Program numbers are not set properly when you timer-record a TV programme using the SHOWVIEW system, the unit will record a TV programme of a different station. When programming the timer using the SHOWVIEW system, be sure to check the desired channel is selected correctly. (pg. 29)
- Your unit memorises all detected stations even if reception of some of them is poor. You can delete those stations with an unacceptable picture. (pg. 86, "Delete A Channel")

INFORMATION

Language for the on-screen display

Auto Set Up also selects the language automatically for the on-screen display depending on the Country setting you have made in step 2 on page 17 (unless you have selected BELGIUM or SUISSE), as shown below.

SUOMI → SUOMI	ITALIA → ITALIANO
PORTUGAL → ENGLISH	MAGYARORSZÁG → ENGLISH
DEUTSCHLAND → DEUTSCH	ESPAÑA → CASTELLANO
POLSKA → ENGLISH	NEDERLAND → NEDERLANDS
NORGE → NORSK	GREECE → ENGLISH
SVERIGE → SVENSKA	OTHER WESTERN → ENGLISH
DANMARK → DANSK	EUROPE → ENGLISH
ÖSTERREICH → DEUTSCH	OTHER EASTERN → ENGLISH
ČESKÁ REPUBLIKA → ENGLISH	EUROPE → ENGLISH

If you want to change the language setting manually, see "On-screen Language Set (DVD Deck Only)" on page 20.

Just Clock

Your unit is equipped with the Just Clock function which provides accurate time keeping through automatic adjustments at regular intervals, by reading data from a PDC signal. If you want to take advantage of this function, simply set it to "ON". (pg. 88)

T-V Link Functions (DVD Deck Only)

When you connect the unit to your TV via a fully-wired 21-pin SCART cable (pg. 15), the following functions are available. You can use these functions only with a TV offering T-V Link, etc.* For details, refer to the instruction manual of your TV.

* Compatible with TVs offering T-V Link, EasyLink, Megalogic, SMARTLINK, Q-Link or DATA LOGIC via a fully-wired 21-pin SCART cable. The degree of compatibility and available functions may differ by system.

TV Auto Power On

The TV will turn on and be set to its AV mode automatically whenever you start playback. For details, refer to the instruction manual of your TV.

Unit Auto Standby

You can use your TV's remote control to turn off the unit. For details, refer to the instruction manual of your TV.

Direct Rec

You can easily start recording the programme that you are watching on your TV. When you use this function, set "DIRECT REC" to "ON". (pg. 79)

Language

- Turn on the unit.
- Turn on the TV and select the AV mode.
- Slide the **TV/DVD** switch to **DVD**.

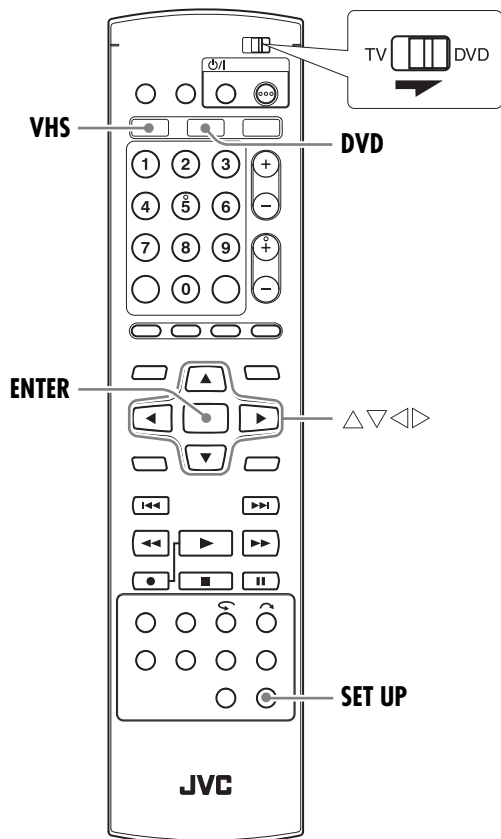

On-screen Language Set (DVD Deck Only)

This unit offers you the choice to view on-screen messages in 10 different languages. Though Auto Set Up selects the language automatically (see pg. 19), you can change the language setting manually as required.

- 1 Press **SET UP** to access the Main Menu screen.
- 2 Press \triangle to select "FUNCTION SET UP", then press ∇ .
- 3 Press \triangle to select "DISPLAY SET", then press ∇ .
- 4 Press \triangle to select "ON SCREEN LANGUAGE", then press **ENTER**.
- 5 Press \triangle to select your desired language, then press **ENTER**.
- 6 Press **SET UP** to complete the setting.

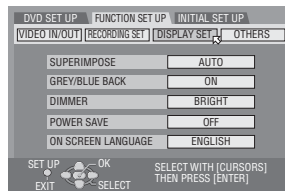

NOTE:

It is not possible to select language of the on-screen display for the VHS deck.

Menu/Audio/Subtitle Language Set (DVD Deck Only)

Some DVD discs contain the DVD menu display, audio and subtitles in multiple languages. With these discs, you can set the default language as you like.

- The procedure shows how to set "MENU LANGUAGE" as an example.

- 1 Press **DVD** so that the DVD lamp lights up on the unit.
 - 2 Press **SET UP** to access the Main Menu screen.
 - 3 Press \triangle to select "DVD SET UP", then press ∇ .
 - 4 Press \triangle to select "LANGUAGE SET", then press ∇ .
 - 5 Press \triangle to select "MENU LANGUAGE", then press **ENTER**.
 - 6 Press \triangle to select your desired language, then press **ENTER**.
- See "Language Code List" (see pg. 96).

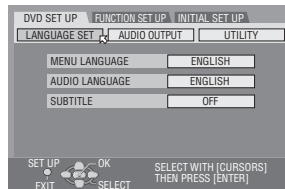

- 7 Press **SET UP** to complete the setting.

NOTE:

When the selected language is not available on the disc, the disc's default menu language is played back.

Monitor Set (DVD Deck Only)

You can select the monitor type depending on the TV used when you play back DVD VIDEO discs recorded for wide-screen TVs.

- Turn on the unit.
- Turn on the TV and select the AV mode.
- Slide the **TV/DVD** switch to **DVD**.

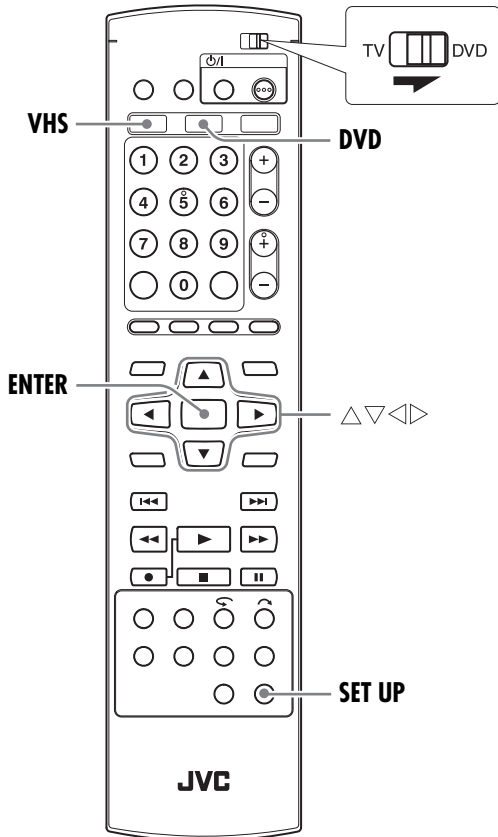

- 1 Press **SET UP** to access the Main Menu screen.
- 2 Press $\triangleleft \triangleright$ to select "FUNCTION SET UP", then press ∇ .
- 3 Press $\triangleleft \triangleright$ to select "VIDEO IN/OUT", then press ∇ .
- 4 Press $\triangle \nabla$ to select "MONITOR TYPE", then press **ENTER**.
- 5 Press $\triangle \nabla$ to select the desired option, then press **ENTER**.
- 6 Press **SET UP** to complete the setting.

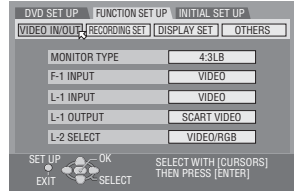

* The **boldface** settings below indicate the settings at your purchase.

- **MONITOR TYPE — 4:3 LB / 4:3 PS / 16:9 AUTO / 16:9 FIX**
- 4:3 LB** (Letter Box conversion): Select this when the aspect ratio of your TV is 4:3 (conventional TV). While viewing a wide screen picture, the black bars appear on the top and the bottom of the screen.
- 4:3 PS** (Pan&Scan): Select this when the aspect ratio of your TV is 4:3 (conventional TV). While viewing a wide screen picture, the black bars do not appear; however, the left and right edges of the pictures will not be shown on the screen.
- 16:9 AUTO** (Wide television conversion): Select this when the aspect ratio of your TV is 16:9 (wide TV).
- 16:9 FIX** (Wide television conversion): Select this when the aspect ratio of your TV is fixed to 16:9 (wide TV). The unit automatically adjusts the screen width of the output signal correctly when playing back a picture whose aspect ratio is 4:3.

Pan&Scan/Letter Box

In general, DVD VIDEO disc are produced for a wide-screen TV with 16:9 aspect ratio.

Material with this ratio will not fit to a TV with 4:3 aspect ratio. There are two styles to display the image, "Pan&Scan" (PS) and "Letter Box" (LB).

Pan&Scan

The right and left side of the image are cut off. The image fills the screen.

- The picture will be shown in the "4:3 LB" mode depending on the disc even if the "4:3 PS" mode is selected.



Letter Box

Black bands appear at the top and bottom of the image. The image itself appears in 16:9 aspect ratio.



Playback

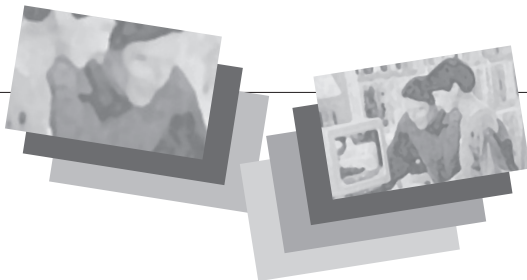

DVD	24
Playback of the programme being recorded (Live Memory playback).....	51
How to search and manage the DVD titles (Navigation)	65
VHS	25

Recording

DVD	26
About recording mode.....	27
VHS	28
About recording mode.....	28

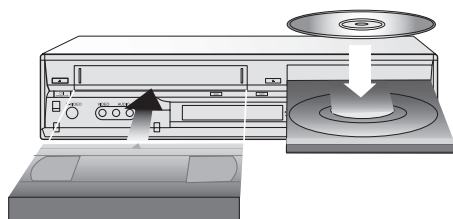

W *hat do you*

Timer recording

Using SHOWVIEW number	29
Setting timer manually	31
How to record a satellite programme	36

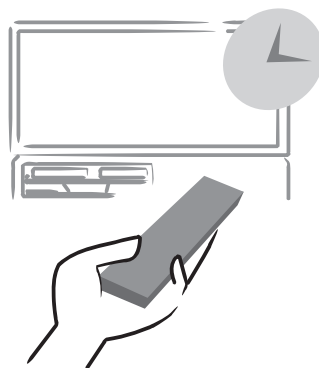

Dubbing

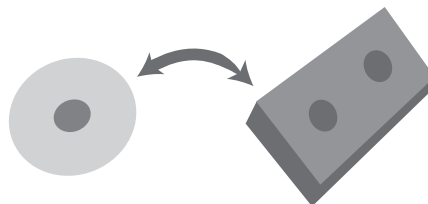

From VHS to DVD	37
From DVD to VHS	39
Dubbing from a digital equipment like a camcorder	41

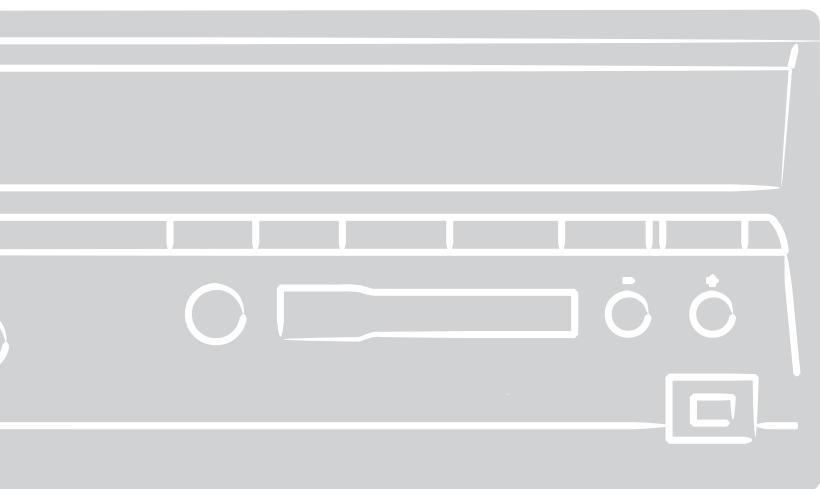

want to do?

Basic Playback (DVD)



- Turn on the unit.
- Turn on the TV and select the AV mode.
- Slide the TV/DVD switch to DVD.

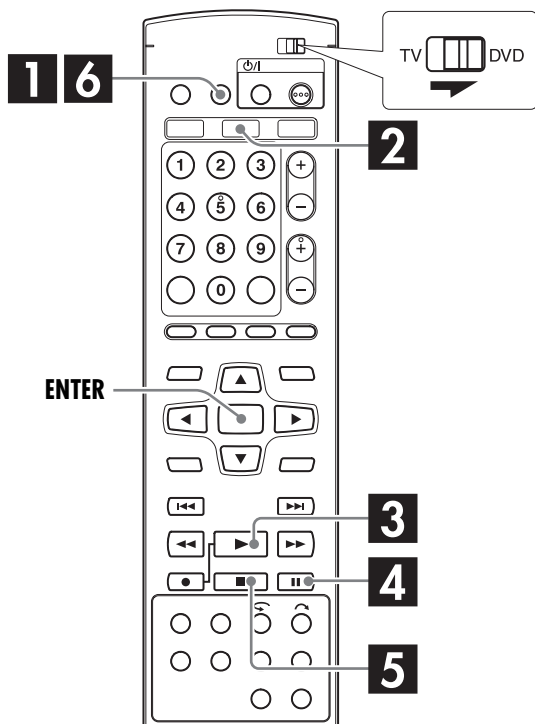
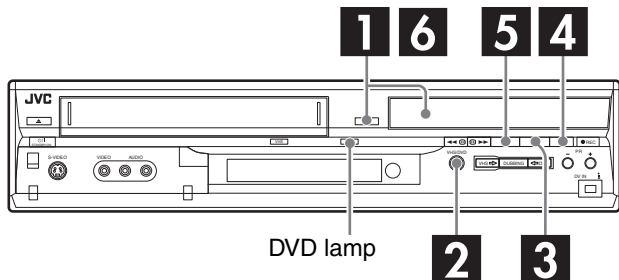

ATTENTION:

- It takes approximately 30 seconds to read a disc depending on the type and condition of the disc since this unit is multi-disc compatible (DVD-RAM, DVD-RW, DVD-R). It may even take several minutes when a disc is dirty, scratched or warped.
- It may take a few seconds to start playback. This is not a malfunction.
- Forward/reverse high-speed search and other operations cannot be performed while playback is stopped.

To play back an MP3/JPEG disc, see “Playback With MP3/JPEG Navigation” (pg. 72).

1 Load a disc.

- For details, refer to “Placing A Disc” (pg. 9).
- Playback begins automatically if an auto-playback DVD disc is loaded.

2 Press VHS/DVD on the unit repeatedly or DVD on the remote control so that the DVD lamp lights up on the unit.

3 Press ► to start playback.

- If you load a DVD disc whose region code does not match the unit, “REGION CODE ERROR” appears on the TV screen. For details, refer to “Region Number” (pg. 7).
- With Video CD discs with PBC control or some DVD discs, the menu display may appear on the TV screen after starting playback. In this case, select an item which you want to play back from the menu. Otherwise, the playback cannot go forward. Refer to “Playback Control (PBC) Function” (pg. 50) or “Locating A Desired Scene Using The DVD Menu” (pg. 47).
- The Library Database DVD Navi also enables you to search and select the desired titles. (pg. 66)

4 Press II to pause playback.

- To resume normal playback, press ►.

5 Press ■ to stop playback.

- When a recordable disc is played, playback stops and a programme received with the unit’s tuner resumes on the TV screen.
- When a playback-only disc is played, playback stops and the TV screen becomes all blue when you press ■. Pressing ■ again resumes a programme received with the unit’s tuner.
- If ▲ (OPEN/CLOSE) is pressed during playback, playback stops, then the disc tray opens.

6 To eject the disc, press ▲ (OPEN/CLOSE).

NOTE:

When the Library Database DVD Navi screen appears, choose a thumbnail image of the desired title on the TV screen, then press ENTER. (pg. 66)

Basic Playback (VHS)

- Turn on the unit.
- Turn on the TV and select the AV mode.
- Slide the TV/DVD switch to DVD.

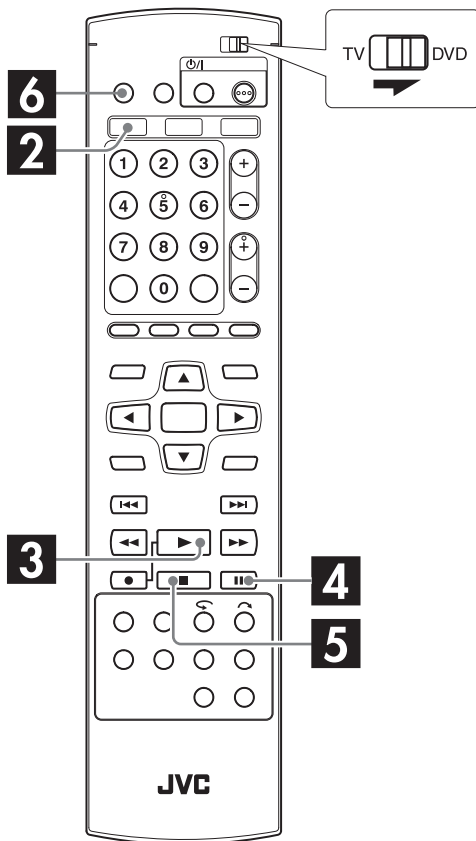
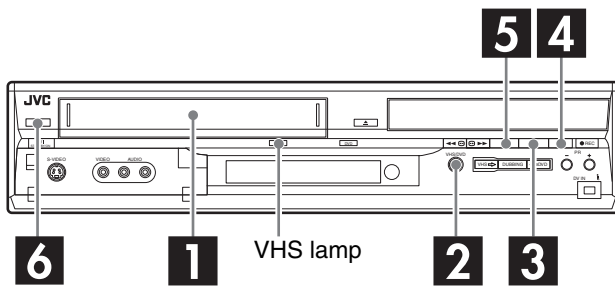

1 Load a cassette.

- Make sure the window side is up, the rear label side is facing you and the arrow on the front of the cassette is pointed toward the unit.
- Do not apply too much pressure when inserting.
- If the record safety tab has been removed, playback begins automatically.
- The unit's power comes on automatically and the counter is reset to 0:00:00.

2 Press VHS/DVD on the unit repeatedly or VHS on the remote control so that the VHS lamp lights up on the unit.

3 Press ► to start playback.

4 Press || to pause playback.

- To resume normal playback, press ►.

5 Press ■ to stop playback.

6 To eject the cassette, press ▲ (EJECT).

Usable cassettes

Full-Size VHS

T-30 (ST-30**) / T-60 (ST-60**) / T-90 / T-120 (ST-120**) / T-160 (ST-160**) / ST-210**

Compact VHS*

TC-20 (ST-C20**) /
TC-30 (ST-C30**) /
TC-40 (ST-C40**)

* Compact VHS camcorder recordings can be played on this unit. Simply place the recorded cassette into a VHS Cassette Adapter and it can be used just like any full-sized VHS cassette.

** This unit can record on regular VHS and Super VHS cassettes.

However, it will record regular VHS signals only.

- S-VHS recording is not possible with this unit.
- This unit is equipped with SQPB (S-VHS QUASI PLAYBACK) that lets you watch tapes recorded in the S-VHS format with regular VHS resolution.
- SQPB does not deliver Super VHS resolution.

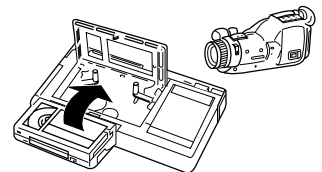

Basic Recording (DVD)

DVD RAM DVD R DVD RW

- Turn on the unit.
- Turn on the TV and select the AV mode.
- Slide the TV/DVD switch to DVD.

ATTENTION:

It is not possible to record programmes on a DVD-R disc which has already been finalised.

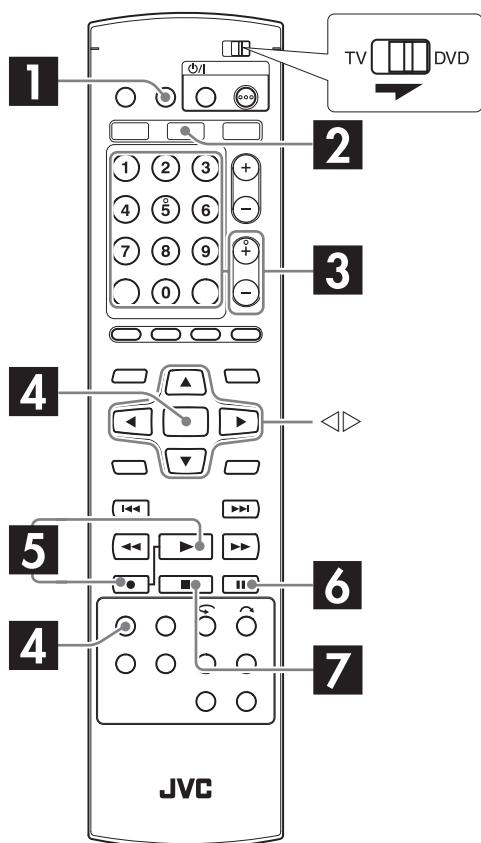
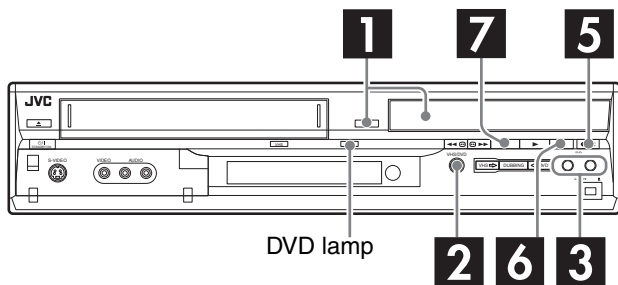

1 Load a recordable disc.

- For details, refer to “Placing A Disc” (pg. 9).

2 Press VHS/DVD on the unit repeatedly or DVD on the remote control so that the DVD lamp lights up on the unit.

3 Press PR +/- or the number buttons to select the channel you wish to record.

- If you record the programmes received by the satellite receiver ...
 - 1) Select “L-2” by pressing PR +/-.
 - 2) Set the satellite receiver to the appropriate channel.

4 Press REC MODE repeatedly to select the recording mode, then press ENTER.

- Each time you press REC MODE, the recording mode changes as follows:

XP → SP → LP → EP → FR60–FR360* → FR420, FR480 → (Back to the beginning)

* The value is selectable from 1 to 6 hours in 5-minutes interval by pressing ◀▶ repeatedly after selecting “FR60–FR360”. To change the value in 30-minutes interval, press and hold ◀▶.

- For details on the recording mode, see “Recording Mode” (pg. 27).

5 Press ● on the unit to start recording. Or while holding ●, press ► on the remote control.

6 Press II to pause recording.

- To resume recording, press ►.

7 Press ■ to stop recording.

- It takes about 10 seconds to end the writing session when you stop recording.

NOTES:

- It is recommended to format a DVD-RAM disc before use if you use the disc on this unit for the first time.
- When using a brand-new DVD-RW disc, format the disc either in VR mode or in Video mode. (☞ pg. 89)
- Recordings made on DVD-R/RW disc must be finalised to play back on other DVD players. Perform “Finalise A Disc (DVD Deck Only)” (☞ pg. 90).
- You can record up to 99 programmes and 999 play lists on each disc.
- Some programmes can only be recorded one time.
- When recording is started, an index of the first part of recording is automatically recorded. (☞ pg. 65) To record satellite programmes, refer to page 36. To delete the index, refer to page 67.
- Recording sometimes may stop or cannot be performed even if there is enough available capacity remaining on the disc.

Recording Mode

MPEG2 format is used as recording format. As a guide for picture quality, the “bps” unit is used to represent how much data can be recorded per second. The larger this value is, the better the picture quality becomes but more capacity is required for the recording. Select XP or SP for programmes where quick movement occurs, such as sports programmes, and LP or EP for talk shows, etc. with relatively less movement.

The recording modes for a 4.7 GB disc are set as follows:

Recording mode	Recording amount (approx.)	Maximum recording time (approx.)
XP	9.6 Mbps	1 hour
SP	5 Mbps	2 hours
LP	2.5 Mbps	4 hours
EP	1.6 Mbps	6 hours
FR60– FR360* (☞ pg. 62)	The amount varies depending on the selected time.	1 – 6 hours
FR420*		7 hours
FR480*		8 hours

* For details on FR mode, refer to “Free Rate Function” (☞ pg. 62).

Recording Resume Function

If there is a power outage during recording, Instant Timer Recording (ITR) (☞ pg. 61) or timer recording (☞ pg. 29, 31), the recording will resume automatically when power is restored to the unit unless the unit’s memory backup has expired.

Basic Recording (VHS)

- Turn on the unit.
- Turn on the TV and select the AV mode.
- Slide the TV/DVD switch to DVD.

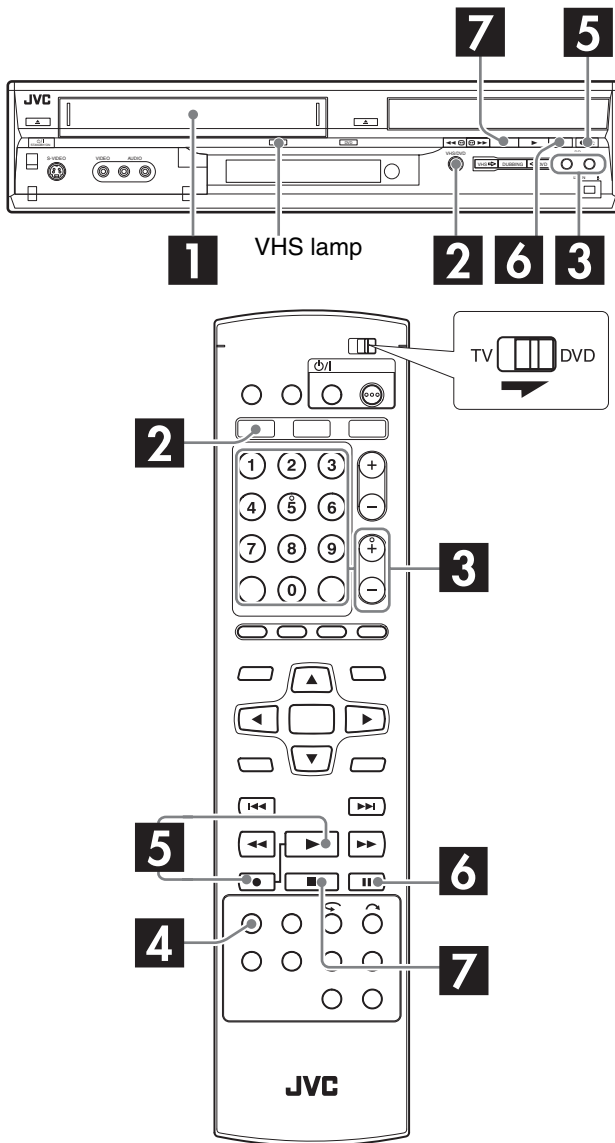

1 Load a cassette with the record safety tab intact.

- The unit's power comes on automatically and the counter is reset to 0:00:00.

2 Press VHS/DVD on the unit repeatedly or VHS on the remote control so that the VHS lamp lights up on the unit.

3 Press PR +/- or the number buttons to select the channel you wish to record.

- If you record the programmes received by the satellite receiver ...
 - 1) Select "L-2" by pressing PR +/-.
 - 2) Set the satellite receiver to the appropriate channel.

4 Press REC MODE repeatedly to set the recording mode.

5 Press ● on the unit to start recording. Or while holding ●, press ► on the remote control.

- If "SUPERIMPOSE" is set to "AUTO" (☞ pg. 79), "MARK" blinks on the screen while an index code is being marked.
- B.E.S.T. takes place at the beginning of both the first SP and the first LP recording after inserting the cassette. (☞ pg. 64)
- If "DIRECT REC" is set to "ON", the programme that appears on the TV screen will be recorded. (☞ pg. 79)

6 Press II to pause recording.

- You can select channel during the Record Pause mode.
- To resume recording, press ►.

7 Press ■ to stop recording.

Recording Mode

Recording mode	Maximum recording time (approx.)	Use
SP	3 hours	Select when the picture quality is important.
LP	6 hours	Select when the time is important. You can record 2 times longer than SP mode.

Recording Resume Function

If there is a power outage during recording, Instant Timer Recording (ITR) (☞ pg. 63) or timer recording (☞ pg. 29, 31), the recording will resume automatically when power is restored to the unit unless the unit's memory backup has expired.

SHOWVIEW™ Timer Programming



You can programme each deck to timer-record as many as 8 programmes up to 30 days ahead. With the SHOWVIEW system, timer programming is greatly simplified because each TV programme has a corresponding code number which your unit is able to recognise. You can use the remote control to enter the SHOWVIEW number.

- Make sure that the unit's built-in clock is set properly.
- Turn on the unit.
- Turn on the TV and select the AV mode.
- Slide the TV/DVD switch to DVD.

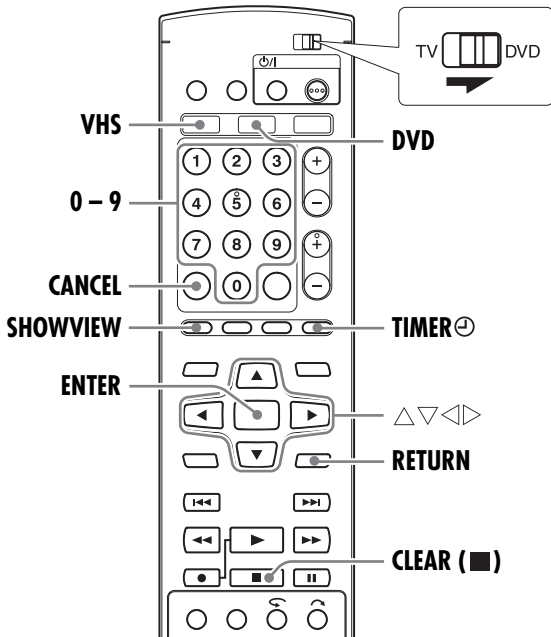

IMPORTANT:
If you have moved to a different area or if a broadcasting station's channel number has been changed, the wrong channel number will be displayed on the SHOWVIEW programme screen in step 5. When this happens, set the correct Guide Program number for that station. (See pg. 83, "SHOWVIEW™ System Setup")

Satellite Receiver Users (DVD Deck Only)
To timer-record a satellite broadcast using the SHOWVIEW system:

- 1 Perform "SHOWVIEW™ Timer Programming".
- 2 Set the satellite receiver to the appropriate channel before the selected programme begins.
- 3 Leave the satellite receiver's power on.

NOTES:

- There may be cases that the SHOWVIEW Timer Programming function prolongs the stop time of the programming.
- When two successive programmes are recorded on a DVD-RW disc with the SHOWVIEW Timer Programming function, the beginning of the second one may be left off the recording.
- SHOWVIEW Timer Programming is not possible on the discs used exclusively for On-Disc Timer Programming.
- If the copy limited programme is received during timer-recording, the unit enters Record Pause mode. Recording starts again if it is switched to a recordable broadcast during the time you programmed.
- To record the programmes received by the satellite receiver, record on the DVD discs. For details, refer to "Satellite Receiver Users (DVD Deck Only)" above.

1 Press **DVD** or **VHS** to select the deck on which you want to perform timer programming.

2 For DVD deck
Load a recordable disc.

For VHS deck
Load a cassette with safety tab intact.

3 Press **SHOWVIEW** to access the SHOWVIEW screen.

4 Press the **number buttons** to enter the SHOWVIEW number of a programme you wish to record, then press **ENTER**.

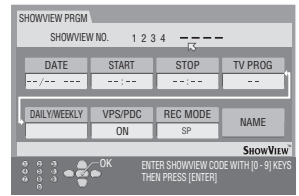

- If you have made a mistake, press **CANCEL** and input the correct number before you press **ENTER**.
 - To clear all entered numbers at a time, press **CLEAR** (■).
 - If the number you entered is invalid, "SHOWVIEW NO. ERROR CONFIRM SHOWVIEW NO. THEN RETRY" appears on the TV screen. Input a valid SHOWVIEW number.
 - If "GUIDE PROGRAMME IS NOT SET" appears on the TV screen, set Guide Program numbers manually. (See pg. 83)
 - When "PROGRAMME FULL DELETE UNWANTED TIMER PROGRAMME" appears on the TV screen, you need to cancel some of the reserved programmes. (See pg. 34)
- 5** The SHOWVIEW number you entered and the matching timer-recording information are displayed on the TV screen. Check the programme data.
- To cancel this setting, press **RETURN**.

IMPORTANT:
Make sure the channel position number you wish to record is displayed; if not, see "SHOWVIEW™ System Setup" (See pg. 83) and set the Guide Program number correctly.

6 Press **◀▶** to select the desired recording option as required. Press **△▽** to select the desired setting, then press **ENTER**.

- "STOP" (To advance/go back the stop time by 30 minutes, press and hold **△▽**).
- "DAILY/WEEKLY" (See pg. 30, "Weekly/Daily Recording")
- "VPS/PDC" (See pg. 30, "VPS/PDC Recording")
- "REC MODE" (See pg. 27, 28, "Recording Mode")
- "NAME" (See pg. 67, "Modify Title Name") (DVD deck only)

7 Press **ENTER** to access the Programme Confirmation screen.

8 Press **ENTER** to complete timer programming.

- To programme another timer, repeat steps **3 – 8**.
- If "PROGRAMME OVERLAPPED" appears on the TV screen, see page 35.

9 Press **TIMER** ⊖ to engage the unit's timer mode. The DVD timer indicator lights up on the unit and the unit is automatically turned off.

- To disengage the timer mode, press **TIMER** ⊖ again.

Weekly/Daily Recording

You can record programmes with one of the following weekly/daily timer settings.

WEEKLY: Select to record a weekly programme.

MON–FRI: Select to record a daily programme from Monday through Friday.

MON–SAT: Select to record a daily programme from Monday through Saturday.

SUN–SAT: Select to record a daily programme from Sunday through Saturday.

VPS/PDC Recording

Now available from some TV stations, PDC (Programme Delivery Control) and VPS (Video Programme System) are services designed to assure safe, accurate timer recording. With this system, special code signals are transmitted together with the audio/video signals. These code signals control your video unit and have precedence over the advertised times you may have preset into the timer. This means that your unit will start and stop recording when the preset TV programmes actually start and end — even if the broadcast time of a preset TV programme is changed.

NOTES:

- When you use Manual Timer Programming, set the start time (VPS or PDC time) exactly as advertised in the TV listing. A different time than advertised will result in no recording.
- VPS/PDC recording is also possible when a satellite receiver or a cable system is connected to [L-2 IN/DECODER] connector on your unit.
- VPS/PDC recording is also possible via the [L-1 IN/OUT] connector.

How to check if the station being received transmits a VPS/PDC signal

- 1 Press **DVD** so that the DVD lamp lights up on the unit.
- 2 Hold down **DISPLAY** for about 5 seconds. “VPS/PDC” appears blinking on the front display panel. If a VPS/PDC signal is detected from the station, “VPS/PDC” will stop blinking. If no VPS/PDC signal is detected from the station, “VPS/PDC” will blink at a slower rate.
- 3 Press **DISPLAY** again to return to normal display.

Manual Timer Programming



You can programme each deck to timer-record as many as 8 programmes up to 30 days ahead. If you do not know the SHOWVIEW number for the programme you wish to record, use the following procedure to set your unit to timer-record the programme.

- Make sure that the unit's built-in clock is set properly.
- Turn on the unit.
- Turn on the TV and select the AV mode.
- Slide the TV/DVD switch to DVD.

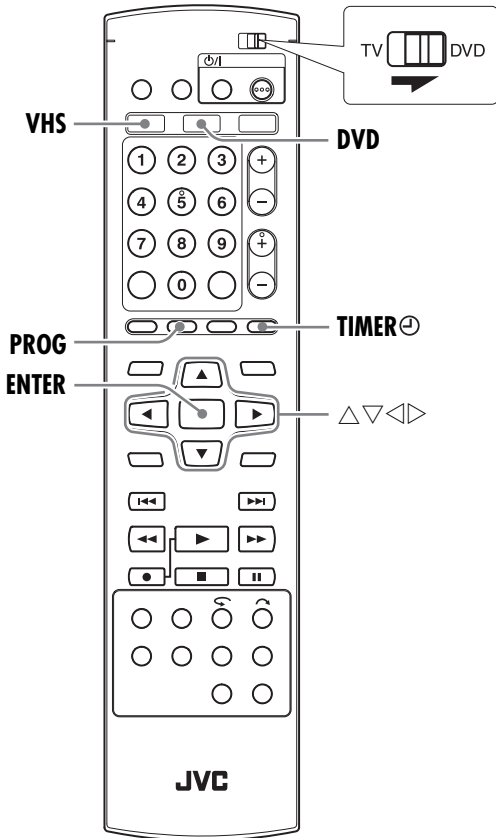

Satellite Receiver Users (DVD Deck Only)
To timer-record a satellite broadcast using Manual Timer Programming:

- 1 Perform "Manual Timer Programming".
- 2 Set the satellite receiver to the appropriate channel before the selected programme begins.
- 3 Select "L-2" in step 8.
- 4 Leave the satellite receiver's power on.

NOTES:

- When two successive programmes are recorded on a DVD-RW disc with Manual Timer Programming function, the beginning of the second one may be left off the recording.
- If the copy limited programme is received during timer-recording, the unit enters Record Pause mode. Recording starts again if it is switched to a recordable broadcast during the time you programmed.
- In case of a power failure after programming, the unit's memory backup keeps your selections for approximately 10 minutes.
- Programmes that start after midnight must have the next day's date.
- To record the programmes received by the satellite receiver, record on the DVD discs. For details, refer to "Satellite Receiver Users (DVD Deck Only)" above.

1 Press **DVD** or **VHS** to select the deck on which you want to perform timer programming.

2 For DVD deck
Load a recordable disc.

For VHS deck
Load a cassette with safety tab intact.

3 Press **PROG** to access the Programme Check screen.

4 For DVD deck
Press $\Delta \nabla \triangleleft \triangleright$ to select "DVD" and press $\Delta \nabla$ to select "NEW TIMER PROGRAMME", then press **ENTER**.

For VHS deck
Press $\Delta \nabla \triangleleft \triangleright$ to select "VHS" and press $\Delta \nabla$ to select "NEW TIMER PROGRAMME", then press **ENTER**.

5 Press $\Delta \nabla$ to set the desired date.

- The current date appears on the TV screen. The date you enter appears in its place.

6 Press $\triangleleft \triangleright$ to select "START", then press $\Delta \nabla$ to set the desired start time.

- Each press of $\Delta \nabla$ advances/goes back the start time in 1-min. increments.
- To advance/go back the start time in 30-min. increments, press and hold $\Delta \nabla$.

7 Press $\triangleleft \triangleright$ to select "STOP", then press $\Delta \nabla$ to set the desired stop time.

- Each press of $\Delta \nabla$ advances/goes back the stop time in 1-min. increments.
- To advance/go back the stop time in 30-min. increments, press and hold $\Delta \nabla$.

8 Press $\triangleleft \triangleright$ to select "TV PROG", then press $\Delta \nabla$ to select the desired channel.

9 Press $\triangleleft \triangleright$ to select the desired recording option as required.

- Refer to step 6 in "SHOWVIEW™ Timer Programming" (pg. 29).

10 Press **ENTER** to access the Programme Confirmation screen.

- 11** Press **ENTER** to complete timer programming.
- To programme another timer, repeat steps 3 – 11.
 - If "PROGRAMME OVERLAPPED" appears on the TV screen, see page 35.

12 Press **TIMER** \odot to engage the unit's timer mode. The DVD timer indicator lights up on the unit and the unit is automatically turned off.

- To disengage the timer mode, press **TIMER** \odot again.

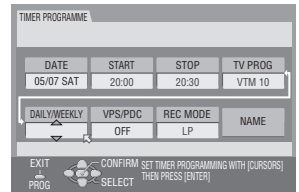
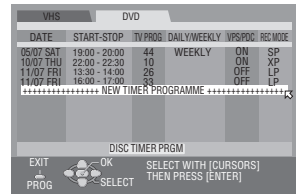

On-Disc Timer Programming (DVD Deck Only)

DVD
RAMDVD
RW

On-Disc Timer Programming is a function used with discs that are especially intended for a specific programme. The disc is then programmed for a programme you always watch every day or every week. Since older programmes are automatically overwritten, a single DVD-RAM/RW (VR mode) disc can be used without worrying about how much recording capacity remains. (☞ pg. 33)

You can programme each disc to timer-record as many as 8 programmes.

- Make sure that the unit's built-in clock is set properly.
- Turn on the unit.
- Turn on the TV and select the AV mode.
- Slide the **TV/DVD** switch to **DVD**.

ATTENTION:

- On-Disc Timer Programming is possible only with the disc for On-Disc Timer Programming.
- If data is recorded on a disc for On-Disc Timer Programming using a unit from another manufacturer, On-Disc Timer Programming may no longer function properly.

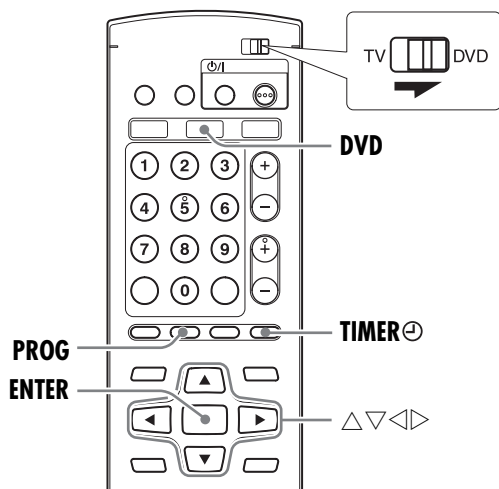

To Make The Disc For On-Disc Timer Programming

- 1 Load a recordable disc.
- 2 Press **DVD** so that the DVD lamp lights up on the unit.
- 3 Press **PROG** to access the Programme Check screen.
- 4 When **On-Disc Timer Programming is made for the first time on the disc**
Press $\triangle\nabla$ to select "DISC TIMER PRGM", then press **ENTER**.
 - When some programmes are recorded on the disc, a caution message appears. In such a case, backup the programmes as required, then format the disc before making On-Disc Timer Programming. (☞ pg. 89)

When On-Disc Timer Programming has already been made on the disc

Press $\triangle\nabla$ to select "NEW TIMER PROGRAMME", then press **ENTER**.

- 5 Press $\triangle\nabla$ to set the desired date.
 - The current date appears on the TV screen. The date you enter appears in its place.
- 6 Press \triangleleft to select "START", then press $\triangle\nabla$ to set the desired start time.

- Each press of $\triangle\nabla$ advances/goes back the start time in 1-min. increments.
 - To advance/go back the start time in 30-min. increments, press and hold $\triangle\nabla$.
- 7 Press \triangleleft to select "STOP", then press $\triangle\nabla$ to set the desired stop time.
 - Each press of $\triangle\nabla$ advances/goes back the stop time in 1-min. increments.
 - To advance/go back the stop time in 30-min. increments, press and hold $\triangle\nabla$.
 - 8 Press \triangleleft to select "TV PROG", then press $\triangle\nabla$ to select the desired channel.
 - 9 Set "DAILY/WEEKLY" option.
 - Refer to step 6 in "SHOWVIEW™ Timer Programming" (☞ pg. 29).
 - It is necessary to set "DAILY/WEEKLY" option for On-Disc Timer Programming. (☞ pg. 30, "Weekly/Daily Recording")
 - 10 Set the other recording options as required.
 - You can select XP, SP, LP, EP or FR480 mode for "REC MODE". However, you cannot select FR (JUST), FR60-FR360 and FR420.
 - Refer to step 6 in "SHOWVIEW™ Timer Programming" (☞ pg. 29).
 - It is not possible to use the Free Rate function. (☞ pg. 62)
 - 11 Press **ENTER** to access the Programme Confirmation screen.
 - 12 Press **ENTER** to complete timer programming.
 - To programme another timer, repeat steps 3 – 12.

Satellite Receiver Users

To timer-record a satellite broadcast using the On-Disc Timer Programming function:

- 1 Perform "On-Disc Timer Programming (DVD Deck Only)".
- 2 Set the satellite receiver to the appropriate channel before the selected programme begins.
- 3 Select "L-2" in step 8.
- 4 Leave the satellite receiver's power on.

To Timer-record The Programme With The Programmed Disc

- 1 Load a programmed disc.
- 2 Press **TIMER**. The unit turns off and "DISC" appears on the front display panel. The DVD timer indicator also lights up on the unit and the unit is automatically turned off.
 - To disengage the timer mode, press **TIMER** again.

NOTES:

- On-Disc Timer Programming is not possible on a DVD-RW disc formatted in video mode. (☞ pg. 89)
- The information of a programme recorded with On-Disc Timer Programming is not stored in the library. (☞ pg. 71)
- The play list is not created for the programmes recorded with On-Disc Timer Programming. (☞ pg. 68)
- Basic Recording (☞ pg. 26), SHOWVIEW Timer Programming (☞ pg. 29), Manual Timer Programming (☞ pg. 31) are not possible on the On-Disc Timer programmed disc.
- The beginning of a programme may not be recorded. Also, if the 1st programme's recording stop time and the 2nd programme's recording start time is the same, the ending of the 1st programme may not be recorded.
- If there is a power cut while recording, the recordings before the power cut are not guaranteed.

How Discs Are Overwritten

(Example 1)
To record a 1-hour serial drama every Friday in SP mode

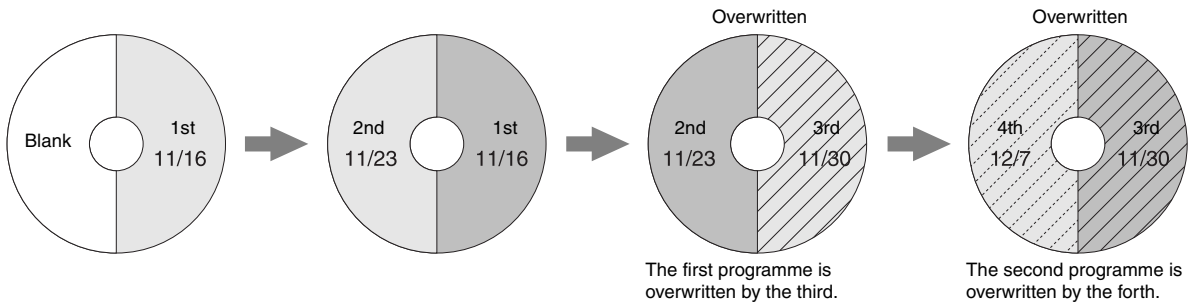

(Example 2)
To record a 15-minute serial drama every morning in XP mode

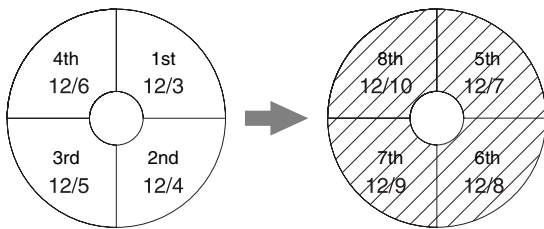

(Example 3)
To record a 90-minute serial drama every Sunday in SP mode

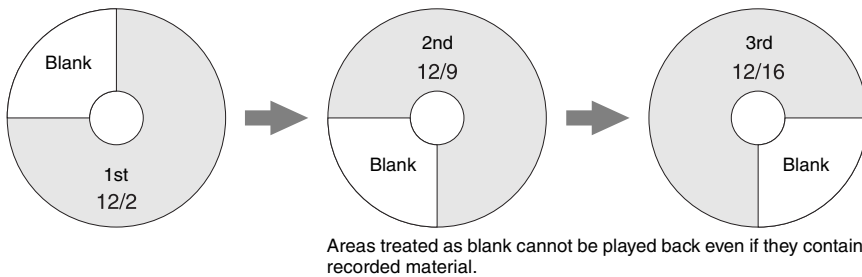

NOTES:

- On-Disc Timer Programming may not always work as these examples.
- On-Disc Timer Programming may not complete successfully if the recording stop time is extended due to VPS/PDC.

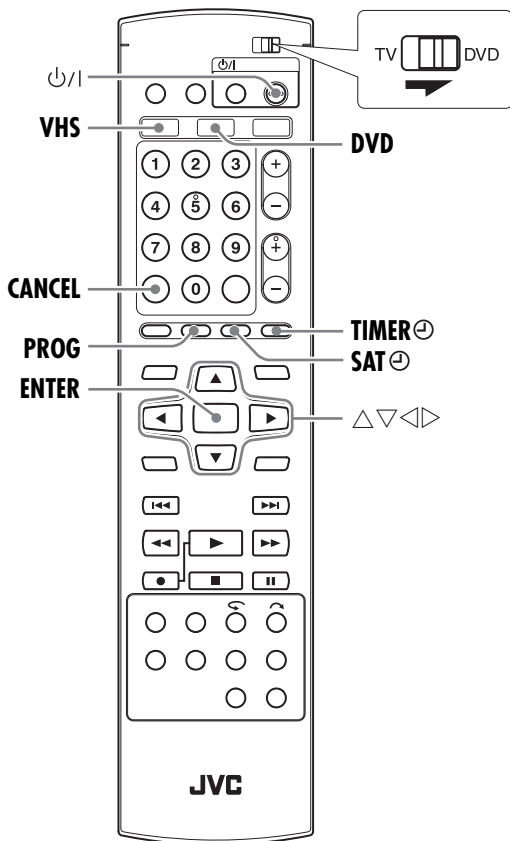

Check, Cancel And Change Programmes

1 When the DVD timer indicator lights on the front display panel

Press **TIMER** ⌚, then press ⏻/⏷.

When “**DISC** ⌚” lights on the front display panel and the DVD timer indicator also lights up on the front display panel.

Press ⏻/⏷.

When “**SAT** 📡” lights on the front display panel

Press **SAT** 📡, then press ⏻/⏷.

2 Press **PROG** to access the Programme Check screen, then press $\Delta \nabla < \triangleright$ to select “VHS” or “DVD”.

- To return to the previous screen after you check the programme, press **PROG** again.

To cancel the programme

Press $\Delta \nabla$ to select a programme to be cancelled, then press **CANCEL**.

3 Press $\Delta \nabla$ to select the programme, then press **ENTER**. The programme screen appears.

4 Change the settings of the desired recording options as required.

- Refer to steps 5 – 10 in “Manual Timer Programming” (pg. 31).

5 Press **PROG** to complete timer correction. The normal screen resumes.

6 For SHOWVIEW, Manual or On-Disc Timer Programming (DVD deck only)

Press **TIMER** ⌚.

For Automatic Satellite Programme Recording

Press **SAT** 📡 for 2 seconds or more.

- The DVD timer indicator also lights up on the front display panel and the VHS deck is automatically selected. When the VHS deck is in timer standby mode, the unit is automatically turned off.

NOTE:

When you check, cancel and change a On-Disc Timer Programming, be sure to insert the On-Disc Timer programmed disc.

Programme’s information on the front display panel

You can check the details of the programmes on the front display panel. However, it is not possible to cancel or change the programme’s setting.

1 Press **PROG**.

- “NEW PROG” or “P-1” (if 8 programmes have already been set) appears.

2 Press $\Delta \nabla$ until the desired programme number (“P-1” to “P-8”) appears, then press **ENTER**.

3 Press \triangleright .

- Each time you press \triangleright , the indication changes as follows (the settings in parentheses are examples):

Date (“DATE 08.03SU”) → Start time (“ON 11:00”) → Stop time (“OFF 11:30”) → Channel (“PR 1”) → Weekly/Daily (“MO-FR DAILY”) → Programme number (“P-1”) and recording mode (“SP”) → (Back to the beginning)

4 Press **PROG** to complete checking.

- The normal display resumes.

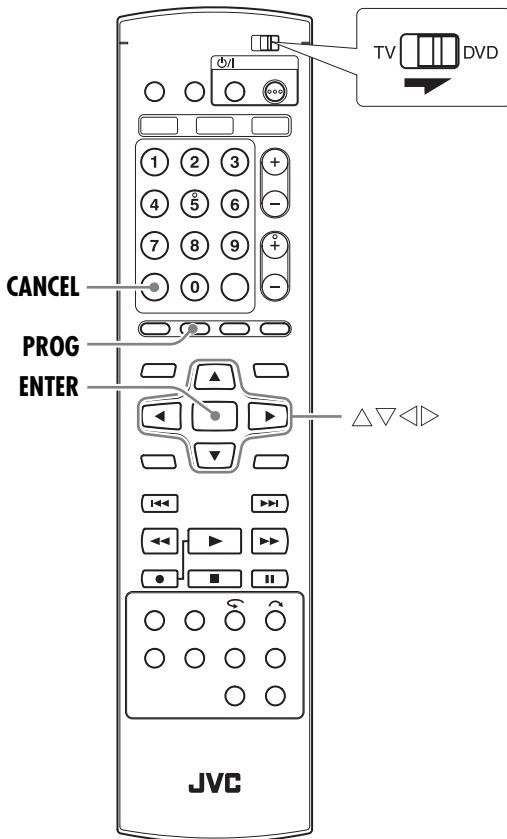

When Programmes Overlap Each Other

If "PROGRAMME OVERLAPPED" appears, you have another programme overlapping the programme you have just made. Confirm with the arrow on "OK", then press **PROG**. The Programme Check screen appears and conflicting programmes will be highlighted in pink.

Example: Programme 3 (you have just made) and programme 4 overlap each other.

VHS		DVD			
DATE	START-STOP	TV PROG	DAILY/WEEKLY	VPS/POC	REC MODE
05/07 SAT	18:10-20:00	L-1		ON	SP
06/07 THU	18:10-20:00	L-1		ON	SP
10/07 THU	19:00-20:00	7	WEEKLY	OFF	XP
10/07 THU	19:45-20:30	7		OFF	LP

***** NEW TIMER PROGRAMME *****

DISC TIMER PROG. [OK]

EXIT [OK] SELECT WITH [CURSORS]
 [PROG] [SELECT] THEN PRESS [ENTER]

1 Confirm the overlapping programmes. Overlapping programmes appear on the TV screen.

NOTE:

If you do not mind this overlap, press **PROG** to finish the timer programme setting. The programme whose start time is earlier will be recorded and the other one will not be recorded correctly.

2 Press $\Delta \nabla$ to select the desired programme to be cancelled or changed.

- If programme on the DVD deck and programme on VHS deck overlap each other, \star mark appears on the left of the date of each item. Press $\Delta \nabla \triangleleft \triangleright$ to select "VHS" or "DVD", then select the programme to be cancelled or changed.

To cancel the programme

Press **CANCEL**.

- "THE TIMER PROGRAMMING SETTING WAS CANCELLED" appears on the TV screen for about 5 seconds, then the normal screen resumes.

To change the programme setting

Press **ENTER**, then go to step 3.

3 Change the programme setting.

- Refer to steps 5 – 10 in "Manual Timer Programming" (pg. 31).

4 Press **PROG** to check if the conflict has been settled. The Programme Check screen appears.

5 Engage the unit's timer mode.

- Refer to step 6 in "Check, Cancel And Change Programmes" (pg. 34).

NOTE:

When any overlaps remain after deletion and modification of programmes, the Programme Check screen remains showing the conflicting programmes. In such a case, repeat the procedure above until the conflict is solved.

Automatic Satellite Programme Recording (DVD Deck Only)

This function allows you to automatically record a satellite programme which is timer-programmed on your external satellite receiver. Connect a satellite receiver to the unit's [L-2 IN/DECODER] connector and programme the timer on the satellite receiver. The unit starts or stops recording by the signals input from the satellite receiver. After recording, the unit's power shuts off automatically.

ATTENTION:

- Be sure not to turn on the satellite receiver before the programme is executed; otherwise, the unit will start recording when the satellite receiver's power is turned on.
- If you have connected another appliance other than a satellite receiver to the [L-2 IN/DECODER] connector, be sure not to engage the Automatic Satellite Programme Recording mode; otherwise, the unit will start recording when the connected appliance's power is turned on.
- Automatic Satellite Programme Recording and timer-recording cannot be done at the same time.

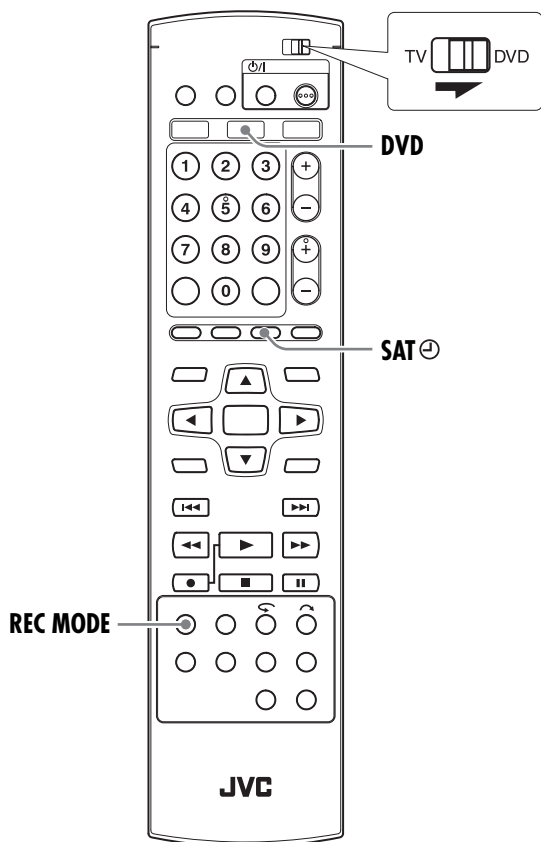

- Make sure the satellite receiver is connected to the unit's [L-2 IN/DECODER] connector.
- Programme the timer on the satellite receiver.
- Slide the TV/DVD switch to DVD.

- 1 Load a recordable disc.
- 2 Press **DVD** so that the DVD lamp lights up on the unit.
- 3 Press **REC MODE** repeatedly to set the recording mode.
- 4 Press and hold **SAT** for about 2 seconds to engage the Automatic Satellite Programme Recording mode. "SAT" appears on the front display panel.

NOTES:

- To disengage the Automatic Satellite Programme Recording mode, press **SAT**.
- If the unit's power is off, it is not possible to engage the Automatic Satellite Programme Recording mode.
- For timer programming of the satellite receiver, refer to the instruction manual of the satellite receiver.
- Automatic Satellite Programme Recording is not possible if your satellite receiver does not have a timer.
- Pressing the unit's **⏻** button while Automatic Satellite Programme Recording is in progress turns off the unit's power and disengages the Automatic Satellite Programme Recording mode.
- If there are more than one satellite programmes you wish to record with Automatic Satellite Programme Recording, it is not possible to set different recording modes for each programme.
- Depending on the type of satellite receiver, the unit may not record a slight portion of the beginning of the programme or may record slightly longer than the actual length of the programme.
- Just Clock (pg. 88) does not work when the Automatic Satellite Programme Recording mode is engaged.
- You can also record a programme from your cable system in the same way if the system has a timer.

One-Touch Expert Dubbing (From VHS To DVD)

- Turn on the unit.
- Turn on the TV and select the AV mode.
- Slide the **TV/DVD** switch to **DVD**.
- Make sure that both the DVD deck and the VHS deck are in the stop mode.

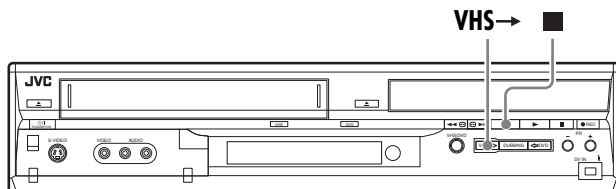

Auto Recording Mode Optimizer

The unit calculates the total recording time of the VHS tape and automatically selects the optimum DVD recording mode.

Auto Title Creation Dubbing

Each index code (VISS signal) on the VHS tape is detected and created as a title on the DVD disc. When a tape contains multiple VISS signals, separate titles are created for each VISS signal (for each programme).

Auto Blank-Cut Dubbing

Recording to the DVD pauses during blank sections on the VHS tape and restarts when a signal is detected.

1 For DVD deck

Load a recordable disc.

- Load an empty disc. If a disc with recorded data is loaded, the time calculation will not include the recorded section, and so dubbing may not be possible for an entire tape.

For VHS deck

Load a cassette you want to dub.

2 Press and hold **VHS→** for more than 2 seconds to start dubbing.

- The unit fast-forwards and rewinds the tape to calculate the recording time, then starts dubbing after setting automatically the recording mode that enables recording to fill exactly one disc. It takes a few minutes to calculate the recording time.
- After dubbing is completed, the VHS deck rewinds the tape automatically and the unit shuts off.
- To cancel dubbing, press **VHS→** again so that "→" lights off.
- To stop dubbing, press **■**.

Stop and pause mode on the DVD deck

When recording, the unit automatically searches for the blank section of the disc no matter where the disc was stopped or paused.

In contrast to VHS tapes, recorded sections on discs cannot be overwritten.

NOTES:

- When you turn on the unit next time, press **VHS→** so that "→" lights off before performing any operations. If it is not done, recording on the DVD deck is not possible.
- It is not possible to dub a tape with a copy protection signal.
- If there is no remaining recording time left on a DVD disc, the tape automatically stops at that position.
- It is not possible to perform other operations like Live Memory Playback. Check the recorded programme on the disc after dubbing.
- It is not possible to perform dubbing on the On-Disc Timer programmed disc. Either cancel the disc programming, or use an unprogrammed disc.
- If the index code (VISS signal) is found on a tape during One-Touch Expert Dubbing, a single title is created. While creating a title, the dubbing stops. Dubbing starts again once the title is created. When a tape contains multiple VISS signals, separate titles are created for each VISS signal.
- During still picture on the VHS deck, the images may jitter, but this is not a malfunction.

Manual Dubbing (From VHS To DVD)

Dubbing A Part Of A Cassette

You can dub the selected scenes on a tape to the DVD disc, starting and stopping wherever you wish.

- Turn on the unit.
- Turn on the TV and select the AV mode.
- Slide the **TV/DVD** switch to **DVD**.
- Make sure that both the DVD deck and the VHS deck are in the stop mode.

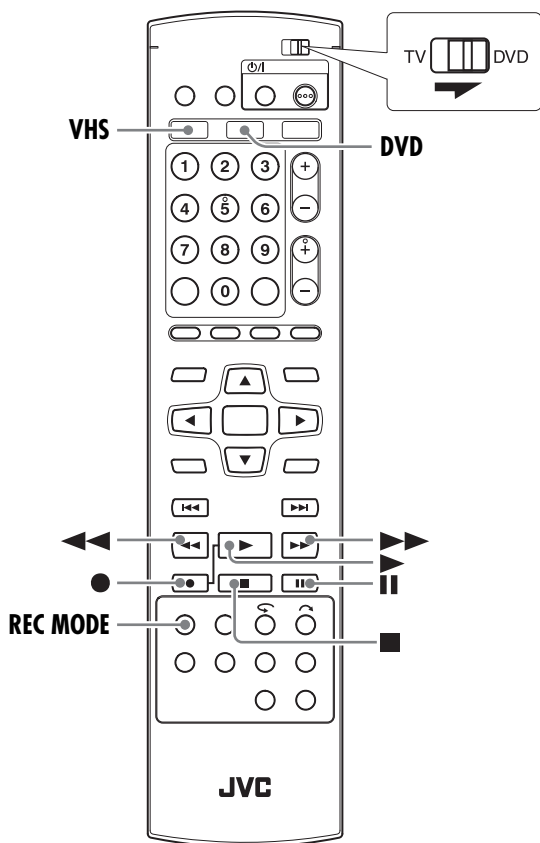
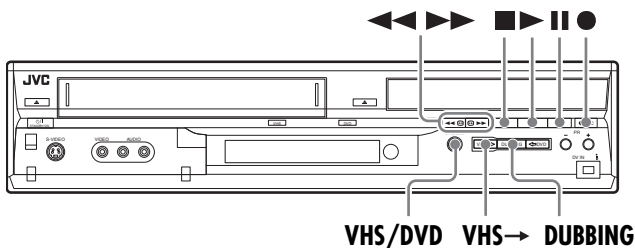

1 For DVD deck

Load a recordable disc.

For VHS deck

Load a cassette you want to dub.

2 Press **VHS->** to select the dubbing direction.

- “->” lights up on the unit.

3 Set “VHS->DVD DUBBING” to “1 PROG”. (pg. 81)

4 Prepare the VHS deck for dubbing.

1 Press **VHS/DVD** on the unit repeatedly or **VHS** on the remote control so that the VHS lamp lights up on the unit.

2 Locate the point from where you want to start dubbing, then pause playback.

- During still picture on the VHS deck, the images may jitter, but this is not a malfunction.

5 Prepare the DVD deck for dubbing.

1 Press **VHS/DVD** on the unit repeatedly or **DVD** on the remote control so that the DVD lamp lights up on the unit.

2 Press **REC MODE** repeatedly to set the recording mode.

3 Press and hold **●**, then press **||** so that the DVD deck enters the Record Pause mode.

6 Press and hold **DUBBING** for more than 2 seconds to start dubbing.

7 Press **■** to stop recording on the DVD deck. Then press **VHS**, and press **■** to stop playback on the VHS deck.

- After dubbing is completed, press **VHS->** so that “->” lights off. If it is not done, recording on the DVD deck is not possible.

NOTES:

- It is not possible to dub a tape with a copy protection signal.
- If there is no remaining recording time left on a DVD disc, the tape automatically stops at that position.
- During Manual Dubbing, if either the VHS deck or DVD deck is stopped, the other deck is not stopped automatically.
- It is not possible to perform other operations like Live Memory Playback. Check the recorded programme on the disc after dubbing.

Disc Dubbing (From DVD To VHS)

Dubbing An Entire Disc

You can easily use this unit for dubbing without connecting any other equipment.

- Turn on the unit.
- Turn on the TV and select the AV mode.
- Slide the **TV/DVD** switch to **DVD**.
- Make sure that both the DVD deck and the VHS deck are in the stop mode.
- Set "SUPERIMPOSE" to "OFF". (☞ pg. 79)

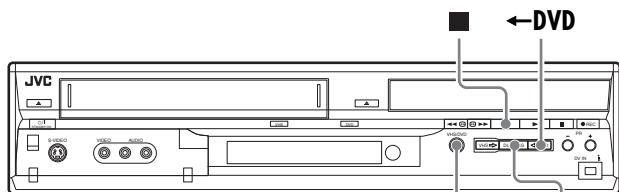

VHS/DVD DUBBING

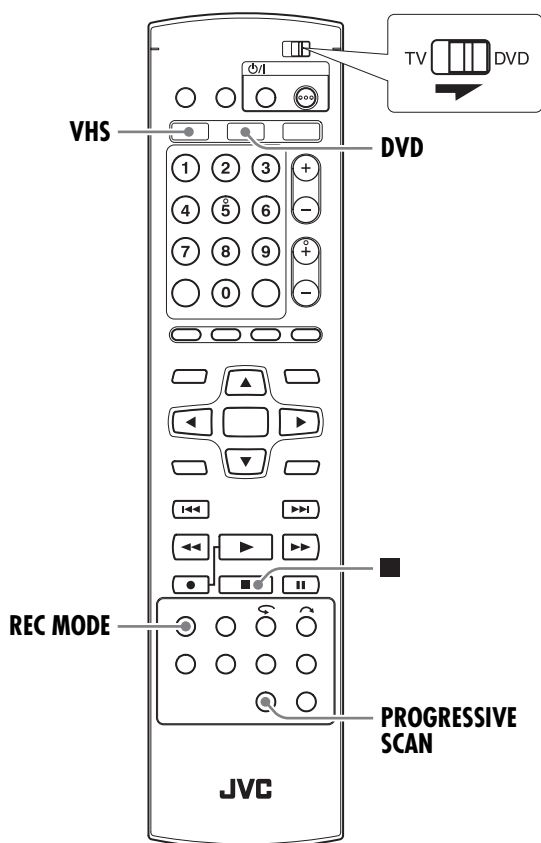

1 For DVD deck

Load a disc you want to dub.

For VHS deck

Load a cassette with the record safety tab intact.

2 Press **VHS/DVD** on the unit repeatedly or **VHS** on the remote control so that the VHS lamp lights up on the unit.

3 Press **REC MODE** repeatedly to set the recording mode.

4 Press **←DVD** to select the dubbing direction.

• "←" lights up on the unit.

5 Press and hold **DUBBING** for more than 2 seconds to start the dubbing.

• If the tape has not been rewound, the VHS deck rewinds the tape automatically. When the VHS deck has finished rewinding, dubbing begins automatically.

• After dubbing is completed, the VHS deck rewinds the tape automatically and the unit shuts off.

• To stop dubbing, press ■.

NOTES:

• When you turn on the unit next time, press **←DVD** so that "←" lights off before performing any operations. If it is not done, recording on the VHS deck is not possible.

• It is not possible to start dubbing if the unit retains a memory of the resume points. Press ■ twice to clear the resume points.

• There may be a discrepancy of several seconds between where you intend dubbing to start, and where it actually starts.

• The superimposed indication during the operation or dubbing is not recorded.

• When the end of the tape is reached during dubbing, the tape is ejected and both deck stops.

• When the progressive mode is set, "←" does not light up on the unit. Press **PROGRESSIVE SCAN** so that video output indicator (P) lights off on the front display panel.

• It may be impossible to dub a DVD-R or DVD-RW (Video mode) disc recorded on the devices from other manufacturers or on a PC. In such case, perform "Manual Dubbing (From DVD To VHS)" (☞ pg. 40).

• It is not possible to perform other operations like Live Memory Playback. Check the recorded programme on the disc after dubbing.

• If "→" lights up on the unit and you play back a DVD VIDEO disc, the images dubbed to the VHS deck may not be output to the TV properly.

Manual Dubbing (From DVD To VHS)

Dubbing A Part Of A Disc

You can dub the selected scenes on a DVD disc to a tape, starting and stopping wherever you wish.

- Turn on the unit.
- Turn on the TV and select the AV mode.
- Slide the **TV/DVD** switch to **DVD**.
- Make sure that both the DVD deck and the VHS deck are in the stop mode.
- Set "SUPERIMPOSE" to "OFF". (pg. 79)

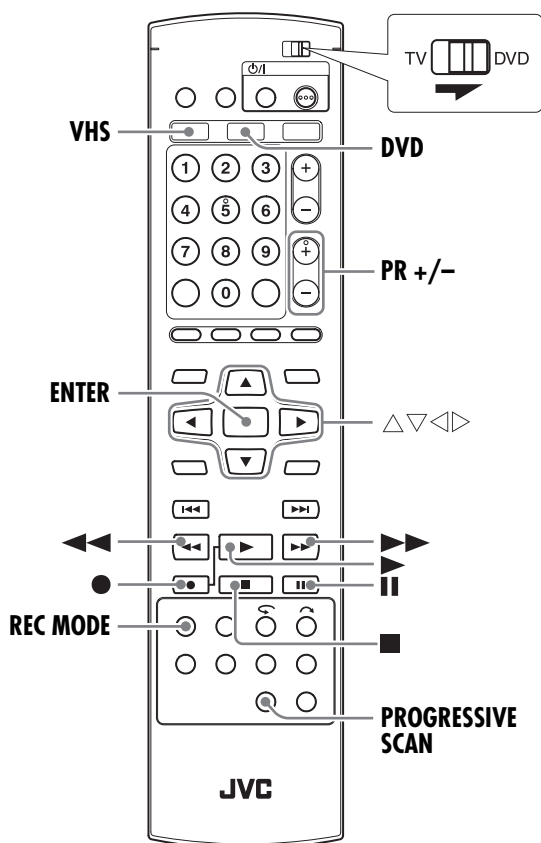
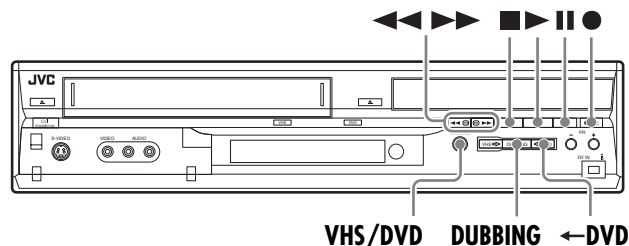

1 For DVD deck

Load a disc you want to dub.

For VHS deck

Load a cassette with the record safety tab intact.

2 Press ←DVD to select the dubbing direction.

- "←" lights up on the unit.

3 Prepare the DVD deck for dubbing.

1 Press **VHS/DVD** on the unit repeatedly or **DVD** on the remote control so that the DVD lamp lights up on the unit.

2 Locate the point from where you want to start dubbing, then pause playback.

4 Prepare the VHS deck for dubbing.

1 Press **VHS/DVD** on the unit repeatedly or **VHS** on the remote control so that the VHS lamp lights up on the unit.

2 Press **REC MODE** repeatedly to set the recording mode.

3 Press and hold **II**, then press **●** so that the VHS deck enters the Record Pause mode.

5 Press and hold **DUBBING** for more than 2 seconds to start the dubbing.

6 Press **■** to stop recording on the VHS deck. Then press **DVD**, and press **■** to stop playback on the DVD deck.

- After dubbing is completed, press ←DVD so that "←" lights off. If it is not done, recording on the VHS deck is not possible.

NOTES:

- It is not possible to start dubbing if the unit retains a memory of the resume points. Press **■** twice to clear the resume points.
- There may be a discrepancy of several seconds between where you intend dubbing to start, and where it actually starts.
- The superimposed indication during the operation or dubbing is not recorded.
- When the end of the tape is reached during dubbing, the tape is ejected and both deck stops.
- When the progressive mode is set, "←" does not light up on the unit. Press **PROGRESSIVE SCAN** so that video output indicator (P) lights off on the front display panel.
- It is not possible to perform other operations like Live Memory Playback. Check the recorded programme on the disc after dubbing.

DV Dubbing (DVD Deck Only)

You can dub programmes from a camcorder or DV equipment connected to the unit with a DV cable. The unit's remote control allows you the limited control of the connected camcorder or DV equipment functions during dubbing.

NOTES:

- Be sure to use the DV cable VC-VDV 204U for connection.
- When you connect a PC to the [DV IN] connector, we do not assure the normal operation of this unit.

Your unit

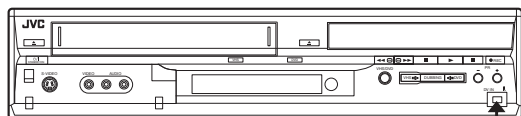

To [DV IN]

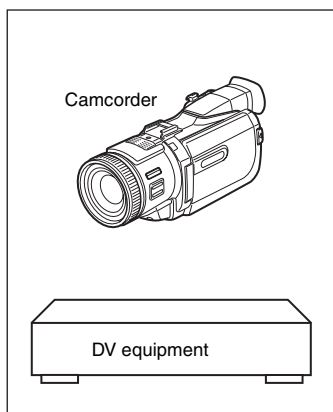

DV cable
(VC-VDV 204U)
(not provided)

DV connector

1 Connect a camcorder or DV equipment to the [DV IN] connector on the unit's front panel.

2 Load a DVD-RAM/RW/R disc on the unit.

3 Press **PR +/-** to set the channel to "DV".

- The "DV DUBBING" controller appears on the TV screen.
- If "CAM" does not appear on the "DV DUBBING" controller, make sure the DV equipment is connected correctly.

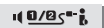
4 Press $\triangleleft \triangleright$ to select , then press **ENTER**.

5 Press $\triangle \nabla$ to select the desired sound track, then press **ENTER**.

AUDIO 1: Select this to record the original stereo sound played back on the connected DV equipment.

AUDIO 2: Select this to record the dubbed stereo sound played back on the connected DV equipment.

MIX: Select this to record the sound of both "AUDIO 1" and "AUDIO 2".

- Note that this selection is not available when the source programme is recorded in 16BIT (48 kHz) mode.

6 Press **REC MODE** repeatedly to set the recording mode.

7 Locate the point from where you want to start dubbing, then stop or pause playback by pressing the following buttons on the remote control: \blacktriangleright , $\blacktriangleright\blacktriangleright$, $\blacktriangleleft\blacktriangleleft$, \blacksquare , \parallel .

- To play back in slow speed (1/10 of the normal speed), press \parallel to pause playback, then press \blacktriangleleft or \blacktriangleright .
- To play back frame-by-frame, press \parallel to pause playback, then press \parallel repeatedly. Each press of \parallel advances a frame.
- To change the playback direction, press \blacktriangleleft or \blacktriangleright .

8 Press $\triangleleft \triangleright$ to select , then press **ENTER**. The dubbing starts.

- Playback on the external DV equipment and recording on the unit should start simultaneously.
- When the playback from the beginning is not possible, the "DV DUBBING" controller cannot be used. Perform dubbing without using the "DV DUBBING" controller. (See below)
- To pause dubbing, press $\triangleleft \triangleright$ to select , then press **ENTER**. Both the unit and the external DV equipment pause dubbing. Pressing \parallel on the unit also works the same way.
- To clear the "DV DUBBING" controller from the TV screen, press **ON SCREEN**.

9 Press \blacksquare on the remote control to stop dubbing.

- Both the unit and the external DV equipment stop dubbing.

NOTES:

- Dubbing copyright guarded programmes is not possible.
- Original DV informations such as the recording date and time are not recorded.
- The superimposed indication during the operation or dubbing is not recorded.
- It is not possible to perform dubbing when "→" lights up on the unit. Press **VHS→** so that "→" lights off.

Performing dubbing without using the "DV DUBBING" controller

- 1** Press **PR +/-** to set the channel to "DV".
- 2** Press **REC MODE** repeatedly to set the recording mode.
- 3** Start playback on the external DV equipment slightly before the actual point from where you wish to start dubbing.
- 4** Press \bullet on the unit to start recording. Or press and hold \bullet and press \blacktriangleright on the remote control. The dubbing starts.
- 5** When the dubbing ends, press \blacksquare on the unit, then stop playback on the external DV equipment.

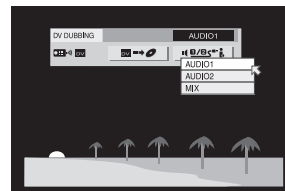

Edit From A Camcorder

You can use a camcorder as the source player and your unit as the recording deck.

1 If the camcorder has no S-VIDEO output connector:

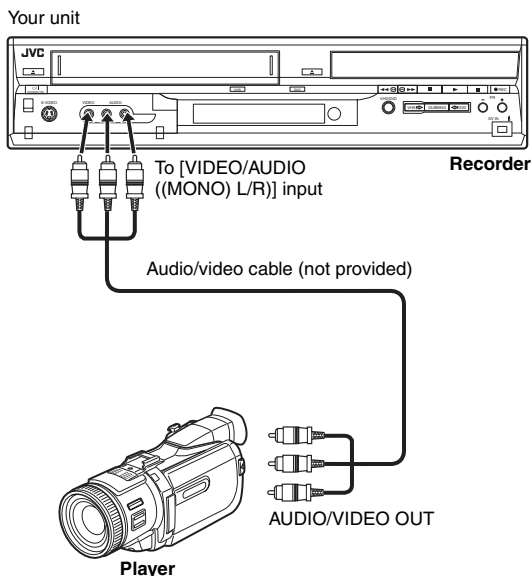

2 If the camcorder has an S-VIDEO output connector (DVD deck only):

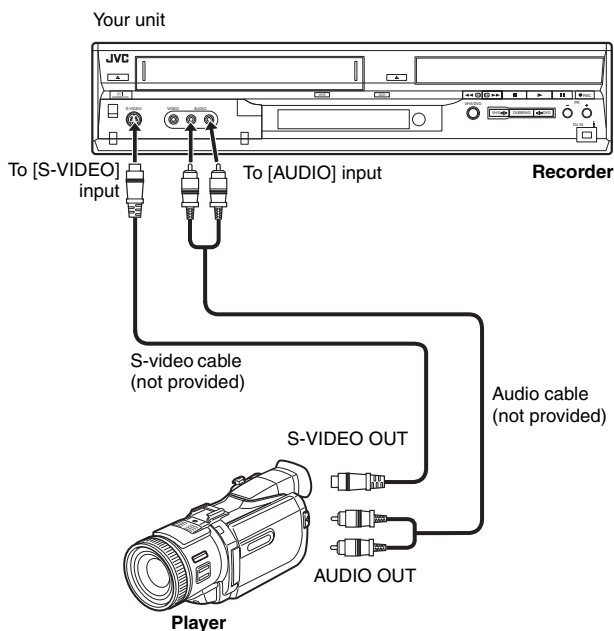

- Slide the **TV/DVD** switch to **DVD**.

1 Make connections.

1 If the camcorder has no S-VIDEO output connector:
— connect the camcorder's AUDIO/VIDEO OUT connectors to the unit's [VIDEO/AUDIO ((MONO) L/R)] input connectors on the front panel.

• When using a monaural camcorder, connect its AUDIO OUT connector to the [AUDIO-L] input connector on your unit.
2 If the camcorder has an S-VIDEO output connector:
— connect the camcorder's AUDIO OUT and S-VIDEO OUT connectors to the unit's [AUDIO] and [S-VIDEO] input connectors on the front panel.

2 Press **VHS/DVD** on the unit repeatedly to select the recording deck.

3 Press **PR +/-** to select "F-1".

• Set "F-1 INPUT" to "VIDEO" for the [VIDEO] input connector, or "S-VIDEO" for the [S-VIDEO] input connector, depending on the connector being used. (pg. 45)

4 Press **REC MODE** repeatedly to set the recording mode.

5 Start playback on the camcorder slightly before the actual point from where you wish to start dubbing.

6 Press **●** on the unit to start recording. Or while holding **●**, press **▶** on the remote control. The dubbing starts.

7 Press **■** on the unit, then stop playback on the camcorder.

NOTES:

- All necessary cables can be obtained from your dealer.
- Refer to the camcorder's instruction manual for operating procedure.
- The quality of dubbed picture becomes poorer than that of the original.

Edit To Or From Another Recorder

You can use your unit as the source player or as the recording deck.

NOTE:

When using another recorder as the recording deck, refer to its instruction manual.

1 When using your unit as the source player:

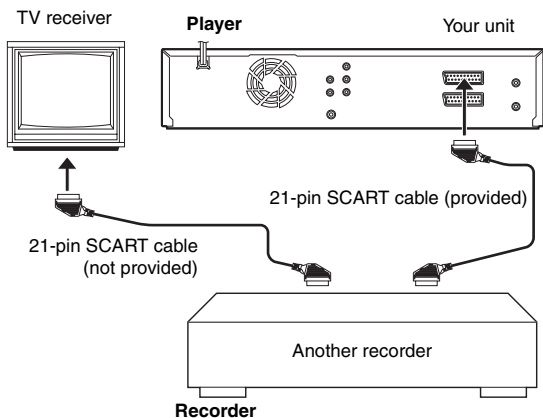

2 When using your unit as the recording deck:

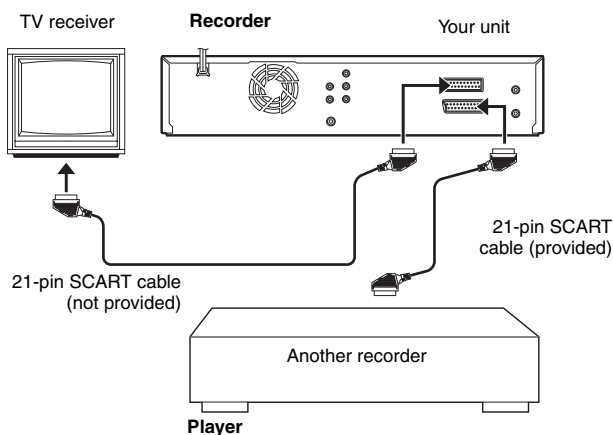

Slide the TV/DVD switch to DVD.

- 1 Connect the player's 21-pin SCART connector to the unit's 21-pin SCART connector as illustrated.
 - 1 When using your unit as the source player:
 - connect its [L-1 IN/OUT] connector to the recording deck.
 - 2 When using your unit as the recording deck:
 - connect its [L-1 IN/OUT] or [L-2 IN/DECODER] connector to the source player.
 - If another recorder is compatible with the Y/C signal (DVD deck only):
 - when using your unit as the source player, set "L-1 OUTPUT" to "SCART S-VIDEO". (↗ pg. 44)
 - when using your unit as the recording deck, set "L-2 SELECT" to "S-VIDEO/RGB". (↗ pg. 45)
 - 2 Press VHS/DVD repeatedly to select the recording deck.
 - 3 Press PR +/- to select "L-1" for the [L-1 IN/OUT] connector, or "L-2" for the [L-2 IN/DECODER] connector, depending on the connector being used when using this unit as the recording deck.
- For DVD deck**
- When using the [L-1 IN/OUT] connector, set "L-1 OUTPUT" to "VIDEO" or "S-VIDEO". (↗ pg. 44)
 - When using the [L-2 IN/DECODER] connector, set "L-2 SELECT" to "VIDEO/RGB" or "S-VIDEO/RGB". (↗ pg. 45)
- 4 Press REC MODE repeatedly to set the recording mode.
 - 5 Engage the Play mode of the source player.
 - 6 Engage the Record mode of the recording deck.
 - 7 Stop recording on the recording deck, then stop playback on the source player.

NOTES:

- All necessary cables can be obtained from your dealer.
- For Y/C signal input/output, be sure to use a 21-pin SCART cable that is compatible with the Y/C signal.
- When you use this unit as the source player for editing, be sure to set "SUPERIMPOSE" to "OFF" before starting. (↗ pg. 79)
- If you are using another recorder with S-Video and Audio output connectors, connect its S-Video and Audio output connectors to this unit's [S-VIDEO] and [AUDIO] input connectors on the front panel. Then, set the unit's input mode to "F-1" in step 3, and set "F-1 INPUT" to "S-VIDEO". (↗ pg. 45) (DVD deck only)

Output/Input Set

- Turn on the TV and select the AV mode.
- Slide the **TV/DVD** switch to **DVD**.

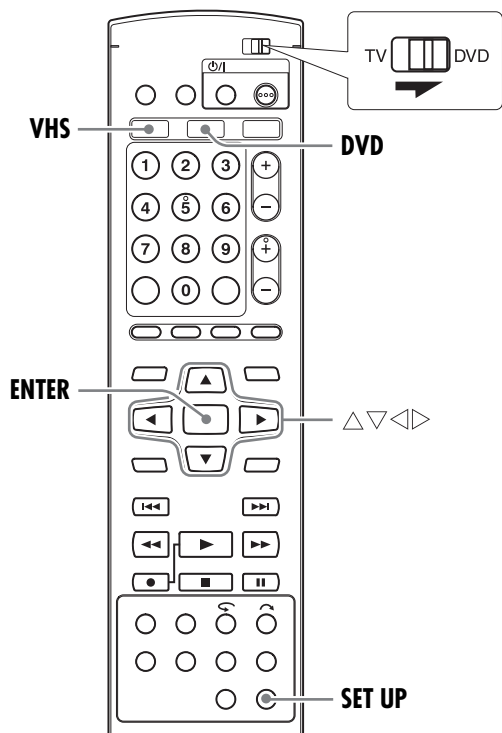

L-1 Output And L-1 Input Setting

The [L-1 IN/OUT] connector accepts and delivers either a composite signal (regular video signal) or a Y/C signal (a signal in which the luminance and chrominance signals are separated). Set "L-1 OUTPUT" and "L-1 INPUT" to the appropriate mode depending on the type of appliance connected to the unit's [L-1 IN/OUT] connector.

- 1 Press **SET UP** to access the Main Menu screen.
- 2 Press $\triangleleft \triangleright$ to select "FUNCTION SET UP", then press ∇ .
- 3 Press $\triangleleft \triangleright$ to select "VIDEO IN/OUT", then press ∇ .
- 4 Press $\triangle \nabla$ to select "L-1 OUTPUT" or "L-1 INPUT", then press **ENTER**.
- 5 Press $\triangle \nabla$ to select the appropriate setting, then press **ENTER**.
- 6 Press **SET UP** to complete the setting.

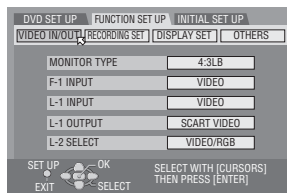

NOTES:

- If "L-1 INPUT" or "L-1 OUTPUT" is set to "S-VIDEO", the monochrome signal is output from VHS deck. Be sure to select setting other than "S-VIDEO" when you use the VHS deck.
- When the progressive mode is set, be sure to set "L-1 OUTPUT" to "COMPONENT". (pg. 44)
- If "L-1 OUTPUT" is not set to "COMPONENT", it is not possible to output images from the [COMPONENT VIDEO OUT] connector.

* The **boldface** settings below indicate the settings at your purchase.

■ L-1 OUTPUT — SCART VIDEO / SCART S-VIDEO / SCART RGB / COMPONENT

SCART VIDEO: If a connected appliance's input is compatible only with regular video signals, set to "SCART VIDEO".

SCART S-VIDEO: If a connected appliance's input is compatible with Y/C signals, set to "SCART S-VIDEO". You can obtain high-quality picture. (For connection, be sure to use a 21-pin SCART cable that is compatible with the Y/C signal.)

SCART RGB: If a connected appliance's input is compatible with RGB signals, set to "SCART RGB". You can obtain a high-quality RGB picture.

COMPONENT: If a connected appliance's input is compatible with Y/Pb/Pr signals, set to "COMPONENT". You can obtain a high-quality Y/Pb/Pr picture. Switch the TV to the input that you can watch component video pictures.

■ L-1 INPUT — VIDEO / S-VIDEO

VIDEO: If a connected appliance's output is compatible only with regular video signals, set to "VIDEO".

S-VIDEO: If a connected appliance's output is compatible with Y/C signals, set to "S-VIDEO". You can obtain a high-quality picture. (For connection, be sure to use a 21-pin SCART cable that is compatible with the Y/C signal.)

NOTES:

- If "L-1 OUTPUT" is set to "SCART S-VIDEO", "SCART RGB" or "COMPONENT", it is not possible to set "L-1 INPUT" to "S-VIDEO".
- If "L-2 SELECT" is set to "DECODER", it is not possible to set "L-1 INPUT" to "S-VIDEO".
- If "L-2 SELECT" is set to "DECODER", it is only possible to set "L-1 OUTPUT" to "SCART VIDEO".
- Component video signals are not output from the [L-1 IN/OUT] connector.
- When Progressive scan mode is engaged, it is not possible to select the setting of "L-1 OUTPUT". (pg. 44)

L-2 Select Setting

Set "L-2 SELECT" to the appropriate mode depending on the type of appliance connected to the unit's [L-2 IN/DECODER] connector.

- 1 Perform steps 1 and 2 of "L-1 Output And L-1 Input Setting" (pg. 44).
- 2 Press Δ / ∇ to select "L-2 SELECT", then press **ENTER**.
- 3 Press Δ / ∇ to select the appropriate setting, then press **ENTER**.
- 4 Press **SET UP** to complete the setting.

NOTES:

- If "L-2 SELECT" is set to "S-VIDEO/RGB", it is not possible to output colour signals correctly from the VHS deck.
- If "L-2 SELECT" is set to "DECODER", only the DVD deck operates properly.

* The **boldface** settings below indicate the settings at your purchase.

■ L-2 SELECT — VIDEO/RGB / S-VIDEO/RGB / SAT VIDEO/RGB / DECODER

Select "VIDEO/RGB" or "S-VIDEO/RGB" to use this unit as the recording deck with the player connected to the [L-2 IN/DECODER] connector, or to use the satellite receiver connected to the [L-2 IN/DECODER] connector.

VIDEO/RGB: If a connected appliance's output is compatible with regular video signals, set to "VIDEO/RGB".

S-VIDEO/RGB: If a connected appliance's output is compatible with Y/C signals, set to "S-VIDEO/RGB". You can obtain high-quality picture. (For connection, be sure to use a 21-pin SCART cable that is compatible with the Y/C signal.)

Select "SAT VIDEO/RGB" to view a satellite programme with the TV set while the unit is turned off. (pg. 76)

SAT VIDEO/RGB: If a connected satellite receiver's output is compatible with regular video signals, set to "SAT VIDEO/RGB".

DECODER: To use a decoder connected to the [L-2 IN/DECODER] connector.

NOTES:

- If you have a satellite receiver or a decoder connected to the [L-2 IN/DECODER] connector, be sure to set "L-2 SELECT" back to appropriate mode after editing.
- If you are not connecting a satellite receiver or a decoder to the [L-2 IN/DECODER] connector, leave "L-2 SELECT" set to "VIDEO/RGB".
- When "L-2 SELECT" is set to "SAT VIDEO/RGB", "SAT" appears on the TV screen or front display panel instead of "L-2".
- If "L-1 OUTPUT" is set to "SCART S-VIDEO", it is not possible to set "L-2 SELECT" to "DECODER" or "SAT VIDEO/RGB".
- If "L-1 OUTPUT" is set to "SCART RGB", it is not possible to set "L-2 SELECT" to "DECODER".
- If "L-1 OUTPUT" is set to "COMPONENT" and "L-2 SELECT" to "SAT VIDEO/RGB" or "DECODER", be sure to connect the [L-1 IN/OUT] connector with a TV.
- If "L-2 SELECT" is set to "S-VIDEO/RGB", the monochrome signal is output from VHS deck. Be sure to select setting other than "S-VIDEO/RGB" when you use the VHS deck.

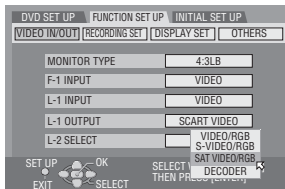

F-1 Input Setting

Set "F-1 INPUT" to the appropriate mode depending on the connector ([VIDEO] or [S-VIDEO]) being used on the front panel.

- 1 Perform steps 1 and 2 of "L-1 Output And L-1 Input Setting" (pg. 44).
- 2 Press Δ / ∇ to select "F-1 INPUT", then press **ENTER**.
- 3 Press Δ / ∇ to select the appropriate setting, then press **ENTER**.
- 4 Press **SET UP** to complete the setting.

* The **boldface** settings below indicate the settings at your purchase.

■ F-1 INPUT — VIDEO / S-VIDEO

VIDEO: When connecting an appliance to the [VIDEO] input connector, set to "VIDEO".

S-VIDEO: When connecting an appliance to the [S-VIDEO] input connector, set to "S-VIDEO".

NOTE:

If "F-1 INPUT" is set to "S-VIDEO", the monochrome signal is output from VHS deck. Be sure to select "VIDEO" when you use the VHS deck.

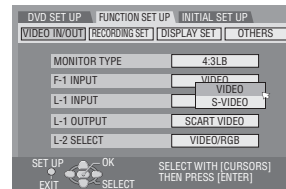

Digital Audio Dubbing

You can dub selected audio from a DVD or Audio CD disc to a digital audio device.

However, it is not possible to dub copy-protected discs.

- Turn on the TV and select the AV mode.
- Slide the **TV/DVD** switch to **DVD**.

Example: Dubbing to an MD

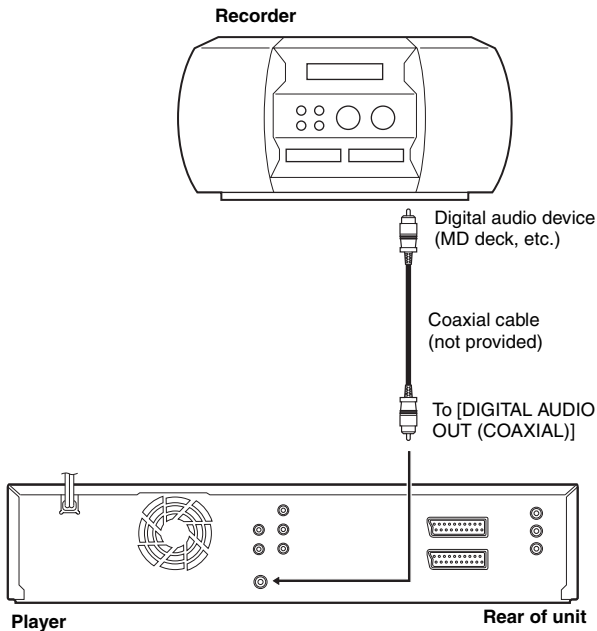

- 1** Connect the unit and a digital audio device using an optional coaxial cable.
- 2** Place a disc on the unit and load an MD or CD on the connected digital audio device.
- 3** Select the audio to be dubbed.
- 4** Start playback slightly before the actual point from where you wish to start dubbing.
- 5** Press **II** to pause playback.
- 6** Select the input mode on the connected digital audio device.
- 7** Press **▶** to start playback on the unit.
- 8** Start recording on the digital audio device.
- 9** Stop recording on the digital audio device. Then press **■** to stop playback on the unit.

NOTE:

There may be a discrepancy of several seconds between where you intend editing to start, and where it actually starts.

Advanced Playback (DVD)

- Turn on the unit.
- Turn on the TV and select the AV mode.
- Slide the TV/DVD switch to DVD.
- Press DVD so that the DVD lamp lights up on the unit.

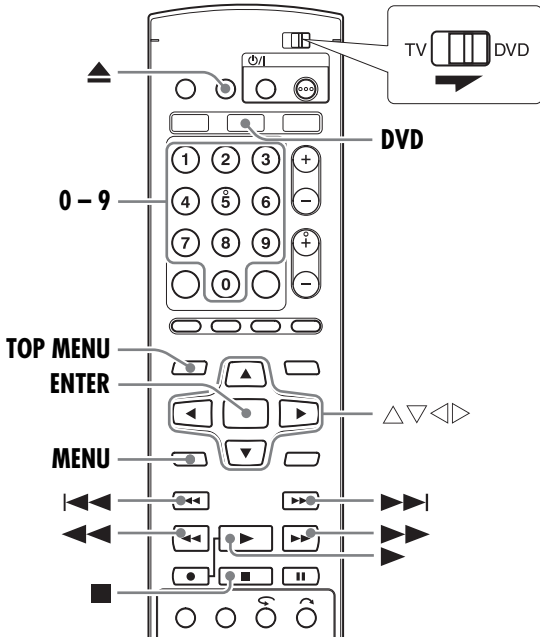

Locating A Desired Scene Using The DVD Menu

DVD VIDEO

DVD VIDEO discs may have top menu and disc menu.

Top menu

DVD discs generally have their own menus which show the disc contents. These menus contain various items such as titles of a movie, names of songs, or artist information. You can locate a desired scene by using the top menu displayed on the TV screen. Press **TOP MENU** to access the top menu.

Disc menu

Disc menus include playback data (angle menu, subtitle menu, etc.) specific to each title.

Press **MENU** to access the disc menu.

1 Press **TOP MENU** or **MENU** to access the DVD menu.

2 Press $\Delta \nabla \triangleleft \triangleright$ to select a desired title, then press **ENTER**. Playback starts.

- It may be possible to select the desired item using the **number buttons** depending on the menu display.

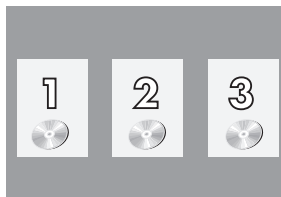

Example:

NOTE:

When "0" appears on the TV screen in step 1, the disc does not have a top menu or disc menu.

Locating The Start Point Of The Item Or Skip The Item



Press $\triangleleft\triangleleft$ or $\triangleright\triangleright$ during playback.

- Pressing $\triangleright\triangleright$ locates the start point of the item or skips the item in the forward direction, then resumes playback.
- Pressing $\triangleleft\triangleleft$ locates the start point of the item or skips the item in the reverse direction, then resumes playback.

When a DVD-RAM/RW/R disc is played

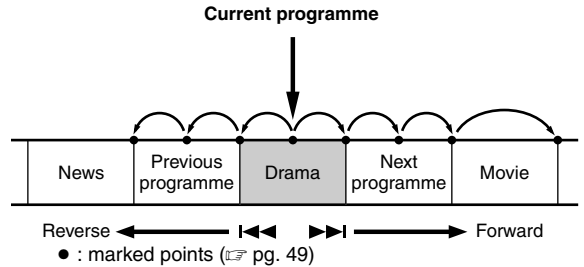

Example:

To locate the beginning of the next item, press $\triangleright\triangleright$ once. To locate the beginning of the current item, press $\triangleleft\triangleleft$ once. To locate the beginning of the previous item, press $\triangleleft\triangleleft$ three times.

When a DVD VIDEO, Audio CD or Video CD disc is played

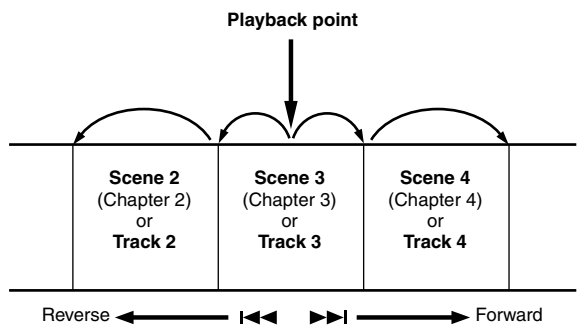

Example:

To locate the beginning of the next item, press $\triangleright\triangleright$ once. To locate the beginning of the current item, press $\triangleleft\triangleleft$ once.

High-Speed Search



During playback, press $\triangleright\triangleright$ for forward high-speed search, or $\triangleleft\triangleleft$ for reverse high-speed search.

- Each press of the button increases the search speed for each direction.
- To resume normal playback, press \triangleright .

For Audio CD

You can perform 4 levels of speed search with $\triangleright\triangleright$ and $\triangleleft\triangleleft$. (Audio is active also during high-speed search.) You cannot perform slow motion for each direction.

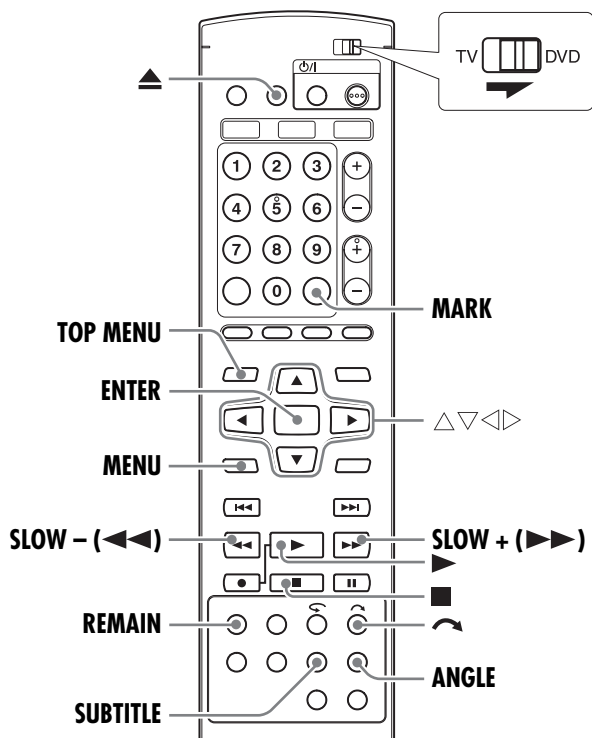

Still Picture/Frame-By-Frame Playback



- 1 Press **II** to pause during playback.
- 2 Press **II** repeatedly to activate frame-by-frame playback.
 - Each press of **<** or **>** advances/reverses the still picture frame by frame.
 - Frame-by-frame playback for reverse direction cannot be performed with Video CD discs.
 - To resume normal playback, press **▶**.

Slow Motion



- 1 Press **II** to pause during playback.
- 2 Press **SLOW -** (**<<<**) or **SLOW +** (**>>>**).
 - Each press of **SLOW -** (**<<<**) or **SLOW +** (**>>>**) increases the slow motion speed for each direction (from 1/16 to 1/2 times the normal speed).
 - Slow motion for reverse direction cannot be performed with Video CD discs.

Skip Search



- During playback, press **↶**.
- Each press initiates an approximately 30-second period of fast-motion playback. Normal playback resumes automatically.

Resume Function



It is possible to memorise the position where you stop playback and resume playback from that position.

- Be sure to set "RESUME" to "ON" or "DISC RESUME". (pg. 80)
- 1 Press **■** during playback to memorise a resume point.
 - The unit enters Resume Stop mode and memorises the position where you have stopped playback as a resume point. (The inside of the disc status indicator on the front display panel blinks while memorising.)
 - The unit retains a memory of the resume points of the last 30 discs played back, even though they have been ejected if "RESUME" is set to "DISC RESUME". (pg. 80)
 - To clear the resume points: (The inside of the disc status indicator stops blinking and lights.)

When "RESUME" is set to "ON":

 - Press **⏻** to turn off the unit.
 - Press **▲** (OPEN/CLOSE) to take out the disc.
 - Press **■** in stop mode.
 - Press **TOP MENU** to display the top menu, then start playback by selecting an item, etc.
 - Press **MENU** to display the disc menu, then start playback by selecting an item, etc.

When "RESUME" is set to "DISC RESUME":

 - Set "RESUME" to "OFF". (pg. 80)
 - Press **■** in stop mode.
 - Press **TOP MENU** to display the top menu, then start playback by selecting an item, etc.
 - Press **MENU** to display the disc menu, then start playback by selecting an item, etc.

- 2 Press **▶** in stop mode to resume playback. The unit starts playback from the resume point.

NOTES:

- "DISC RESUME" setting works on DVD VIDEO, VCD and already finalised DVD-R/DVD-RW (video mode) discs. For other types of discs, the function under "ON" setting will be applied even if "RESUME" is set to "DISC RESUME". (pg. 80)
- If you stop the playback of a disc for which a resume point has already been memorised, the memory will be updated with the new resume point.
- After the unit has memorised the resume points for 30 discs, remembering a new resume point will cause the unit to delete the oldest memorised point. Stopping playback of a disc for which a resume point is already stored may change the order in which the points are stored. This may potentially change the order in which points are deleted.
- When the unit memorises a resume point for a disc, it also remembers audio language, subtitle and angle settings.
- This function may not work for some Video CDs.
- When "RESUME" is changed to "ON" or "OFF" (pg. 80), resume points of the discs memorised with "RESUME" set to "DISC RESUME" will be cleared.
- Resume points are memorised for each side of a double-sided disc.

Marking Positions To Play Back Again Later



It is possible to mark positions (up to 999 points) where you want to play back once again later, and start playback from a marked position. Marking onto DVD-RAM/RW (VR mode only) discs when recording is helpful to locate a start point when you play back the discs later.

To mark positions:

During playback, press **MARK** at positions you want to mark.

- “MARK” appears on the TV screen. You can easily locate the marked positions using **◀◀** or **▶▶** when you play back the disc.

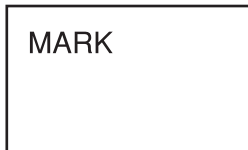

To delete the marked positions:

While paused, press **◀◀** or **▶▶** to locate a marked position you want to delete, then press **MARK**.

- Crossed “MARK” appears on the TV screen, and the marked position is deleted.



NOTES:

- When a monaural or bilingual programme changes to a stereo programme while recording, a mark signal is automatically recorded.
- Titles will be divided into “chapters” at the marked points according to the disc types as follows:
 DVD-R/RW (Video mode): After finalising, titles are divided into “chapters” at the marked points that are marked automatically approximately every 5 minutes during recording before finalising. (☞ pg. 90)
 DVD-RW (VR mode): After finalising, titles are divided into “chapters” at the marked points that are marked at the desired locations during playback before finalising. (☞ pg. 90)
 DVD-RAM: Titles are divided into “chapters” at the marked points that are marked at the desired locations during playback.
 DVD VIDEO and finalised disc: Creating of marked points are not permitted.

Checking The Time Information



You can check time information of a disc on the front display panel and the TV screen.

Each press of **DISPLAY** changes the display as follows:

■ DVD-RAM/DVD-R/DVD-RW

During recording

Current title elapsed time → Disc remaining time* → Clock time (front display panel only) → (back to the beginning)

- * only discs before finalising
- Clock time is displayed only when a recordable disc is recorded.

During playback

Current title elapsed time → Disc remaining time* → Each title elapsed time → (back to the beginning)

- * only discs before finalising

In stop mode or during playback

- It is possible to check disc remaining time according to recording modes also by pressing **REMAIN**.
- In FR mode, it is possible to set recording time in detail. While the recording mode and the disc remaining time are displayed by pressing **REMAIN**, press **△▽** to select “FR”, then press **◀▶** to select the desired recording time. (☞ pg. 62)
- It is not possible to switch the recording mode during playback or while recording.

■ Video CD/Audio CD

During playback

Current track elapsed time → Current track remaining time → Total elapsed time → Total remaining time → (back to the beginning)

In stop mode

0:00 → Playback time of track 1 → 0:00 → Total length of a disc → (back to the beginning)

NOTE:

When a PBC-compatible Video CD disc is loaded, deactivate the PBC function. (☞ pg. 50)

Angle Selection



You can enjoy a variety of scene angles if a DVD VIDEO disc contains “multi-angle” parts, where the same scene was shot from different angles.

If the disc contains “multi-angle” parts, “” appears on the TV screen at the beginning of the “multi-angle” part.

1 Press **ANGLE** during playback.

The angle selection display appears on the TV screen.



When 3 scene angles are contained.

2 Press **ANGLE** or **◀▶** to select your desired angle.

- Each time you press **ANGLE** or **◀▶**, the angle changes.
- When “” appears on the TV screen, the current scene is not recorded from multiple angles. In addition, some discs prohibit angle selection.
- To clear the angle selection display, press **ENTER**. In addition, the angle selection display disappears automatically if no operation is done for 10 seconds.

Subtitle Selection



Some DVD VIDEO discs contain more than one subtitle language, from among which you can choose the desired subtitle language.

“” appears on the TV screen at the beginning of the part where more than one subtitle language are recorded.

1 Press **SUBTITLE** during

playback. The subtitle selection display appears on the TV screen.



When 3 subtitle languages are contained.

- Each time you press **SUBTITLE**, the subtitle display is switched on and off.

2 Press **◀▶** to select your desired language.

- To clear the subtitle selection display, press **ENTER**.

NOTES:

- When “” appears on the TV screen, no subtitle language is recorded.
- When the subtitle language won't be changed with the procedure above, change the subtitle on a disc menu displayed by pressing **MENU**.

Audio Language/Sound Selection



Some DVD VIDEO discs contain the multiple audio language or sound. You can select the desired audio language or sound. For some Video CD discs, you can switch the audio channel to choose Karaoke either with or without the vocal.

1 Press **AUDIO** during playback. The Audio Language/Sound selection display appears.



2 Press **AUDIO** or $\triangleleft \triangleright$ to select your desired audio language/sound.

When 3 audio languages are contained.

- Each time you press **AUDIO** or $\triangleleft \triangleright$, the audio language/sound changes.
- To clear the Audio Language/Sound selection display, press **ENTER**.

NOTES:

- When "S" appears on the TV screen, no audio language is recorded.
- When the audio language won't be changed with the procedure above, change the audio on a disc menu displayed by pressing **MENU**.
- Pressing **AUDIO** to select the audio language/sound is only possible during playback. It is not possible to select by pressing **AUDIO** in stop mode. However, you can select the desired audio language/sound from the setup menu while in stop mode.

Audio Channel Selection



When watching bilingual programmes or playing discs on which you recorded bilingual or stereo programmes, you can choose the desired audio channel.

- When "SUPERIMPOSE" is set to "AUTO", you can confirm on the TV screen the audio channel you have chosen. (☞ pg. 79)
- Each time you press **AUDIO**, the audio channel changes.



TRACK	USE
On-Screen Display	
	For main and sub audio of bilingual programme
	For main audio of bilingual programme
	For sub audio of bilingual programme
	For stereo discs
	For audio of left channel
	For audio of right channel

NOTE:

It is not possible for DVD-R/DVD-RW (Video mode) disc playback to switch the audio channel.

When you can't switch the audio channel of a bilingual programme

When the unit is connected with a digital audio device using an optional coaxial cable and "DIGITAL AUDIO OUT" is set to "DOLBY DIGITAL/PCM", it is not possible to switch the audio channel of a bilingual programme recorded on a DVD-RAM or DVD-RW (VR mode) disc. (☞ pg. 77) In this case, perform the following steps using the remote control to switch "DIGITAL AUDIO OUT" from "DOLBY DIGITAL/PCM" to "PCM ONLY".

- 1 Press **SET UP** to access the Main Menu screen.
- 2 Press $\triangleleft \triangleright$ to select "DVD SET UP", then press ∇ .
- 3 Press $\triangleleft \triangleright$ to select "AUDIO OUTPUT", then press ∇ .
- 4 Press $\triangle \nabla$ to select "DIGITAL AUDIO OUT", then press **ENTER**.
- 5 Press $\triangle \nabla$ to select "PCM ONLY", then press **ENTER**. (☞ pg. 78)
- 6 Press **SET UP** to complete the setting.
- 7 Press **AUDIO** to select the desired audio channel.

Playback Control (PBC) Function



Some Video CD discs support the PBC function. PBC is an abbreviation of "Play Back Control". A Video CD disc recorded with PBC has its own menus, such as a list of the songs on the disc. You can locate a specific scene by using the menu.

1 Press \blacktriangleright in stop mode. The PBC menu appears.

2 Press the **number buttons** to enter the number of the desired scene. The unit starts playback of the selected item.

- "PBC" appears on the front display panel.
- When "NEXT" or "PREVIOUS" appears on the TV screen: Pressing **NEXT** ($\blacktriangleright \blacktriangleright$) advances to the next page. Pressing **PREVIOUS** ($\blacktriangleleft \blacktriangleleft$) returns to the previous page.
- You can return to the menu by pressing **RETURN**.
- The method of the operation is different depending on the disc.

NOTES:

- If you want to playback a PBC-compatible Video CD disc without activating the PBC function, start playback in stop mode by using the **number buttons**, instead of the \blacktriangleright button, to choose the track, then press **ENTER**.
- To activate the PBC function when a PBC-compatible Video CD disc is being played back without the PBC function, press **TOP MENU**, or press \blacksquare then press \blacktriangleright .

Live Memory Playback (DVD Deck Only)

DVD RAM

- Turn on the unit.
- Turn on the TV and select the AV mode.
- Slide the **TV/DVD** switch to **DVD**.
- Press **DVD** so that the DVD lamp lights up on the unit.

This unit records pictures onto the DVD-RAM discs, instead of video tapes, then plays back the pictures recorded on the discs. This makes it possible to achieve high-speed writing and read-out that has not been possible with conventional VHSs, enabling recording and playback simultaneously.

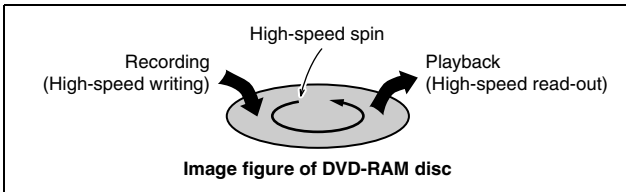

It is called "Live Memory Playback" to start playback of the programme being recorded, with a time-lag between a recording point and a playback point, as shown in the figure below.

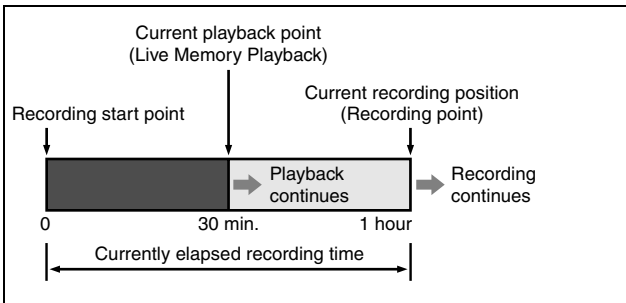

Not only can this unit play back a programme previously recorded while recording or timer recording another programme, but the unit also allows you to play back from the beginning of a programme while continuing to record the same programme.

Recording/Playback Status Display

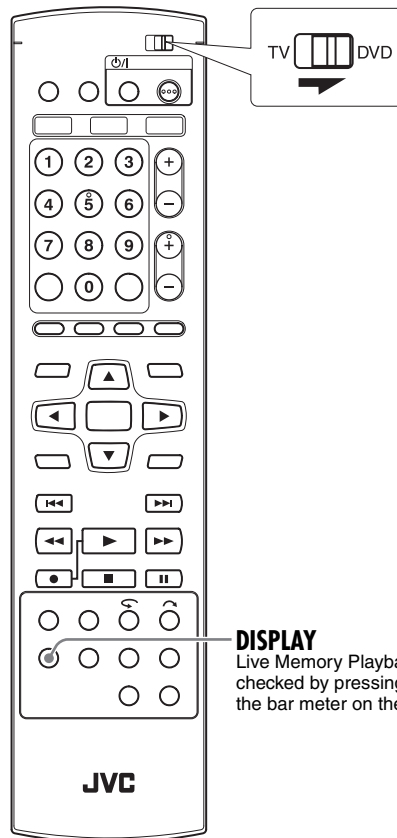

Press **DISPLAY**. The current status is superimposed on the TV screen.

Bar meter display



Superimpose display

Overview Of Live Memory Playback

You can play back a programme you are recording from the beginning while continuing to record or timer record onto a DVD-RAM disc. This is called "Live Memory Playback".

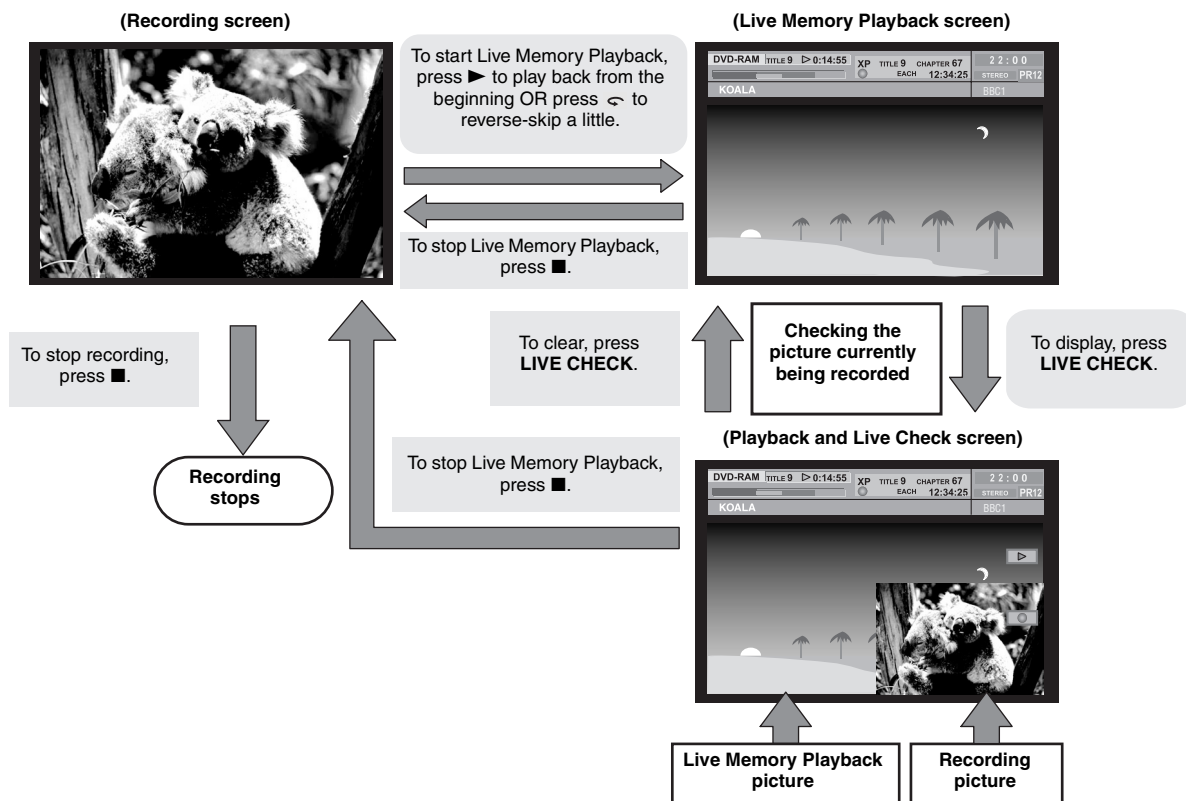

NOTES:

- Live Memory Playback could be performed approximately 30 seconds after recording has started.
- Although high-speed search up to approximately 30 seconds before the current recording point is possible during Live Memory Playback, once the current recording point is reached, the unit resumes normal playback and maintains a delay of approximately 30 seconds so that recording and playback can continue.
- When using Live Memory Playback during timer recording, playback continues even after the end of the recording.
- When using Live Memory Playback during timer recording, playback is automatically stopped just before recording starts, and then recording starts when the time arrives for the next timer-programme.
- It is impossible to perform ITR even if you press ● during Live Memory Playback. (☞ pg. 51)
Press ■ to display the programme being recorded, then perform ITR settings.
- Playback may be paused for a moment during Live Memory Playback, which does not interfere with recording.
- Live Memory Playback cannot be performed while recording the source from DV input. (☞ pg. 41, "DV Dubbing (DVD Deck Only)")
- When **LIVE CHECK** is pressed to display the picture currently being recorded, the picture size may not be correct.

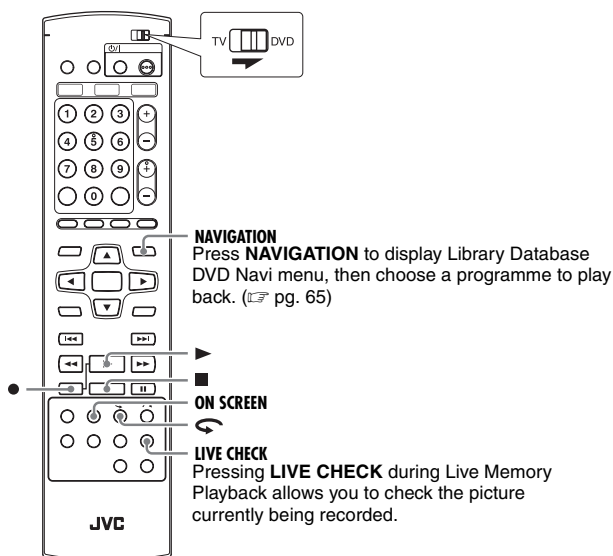

Display During Live Memory Playback

During recording, you can watch at your will what was previously recorded or is currently being recorded. It is possible to perform freely normal playback operations (forward/reverse high-speed search and variable-speed search) within the range of the red or blue bar on the TV screen.

When Live Memory Playback reaches the point of 30 seconds before the current recording point by forward high-speed search or other operations, the unit returns to normal playback.

The superimpose display appears by pressing **ON SCREEN**. (pg. 12)

The Live Check picture is displayed on the bottom right corner by pressing **LIVE CHECK**.

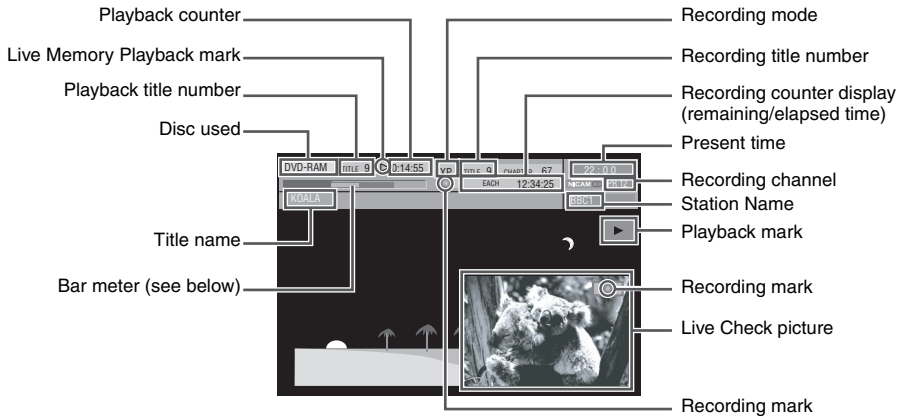

This unit displays the current recording/playback status by the bar meter.
(Example of bar meter display)

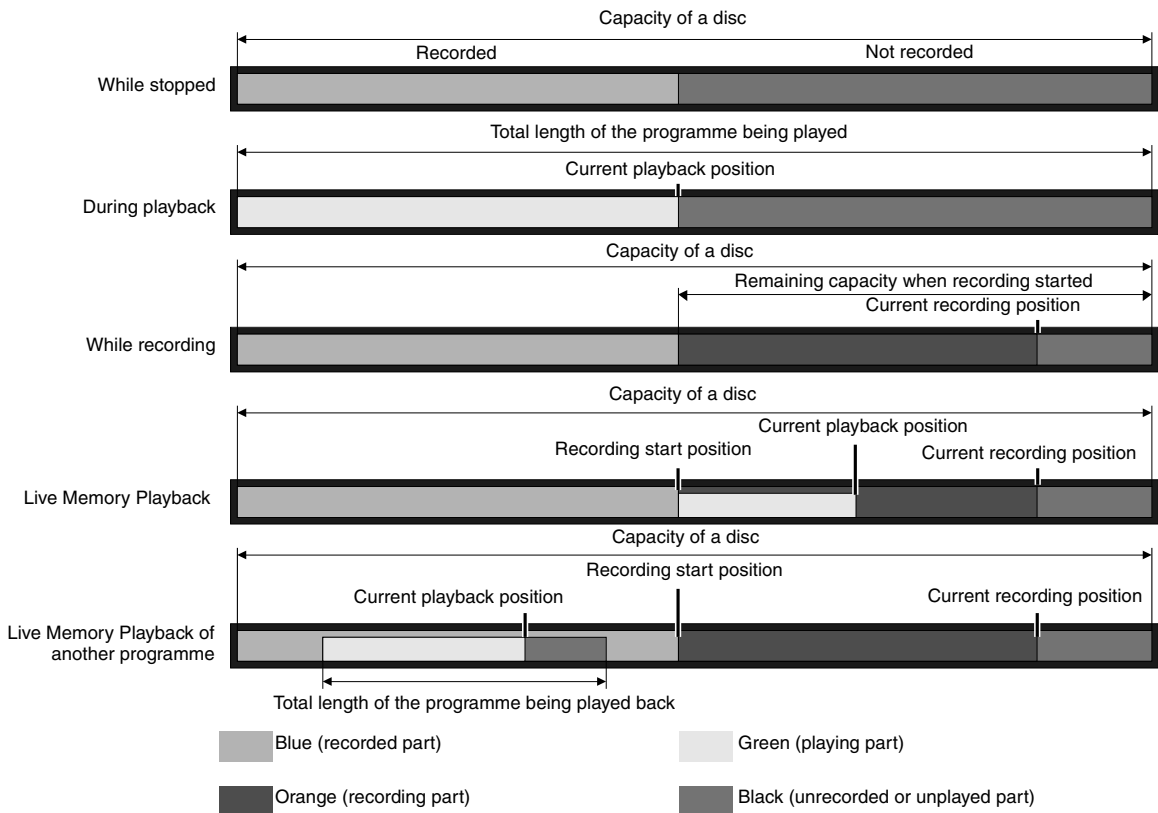

Buttons To Be Used During Live Memory Playback

- Turn on the unit.
- Turn on the TV and select the AV mode.
- Slide the **TV/DVD** switch to **DVD**.
- Press **DVD** so that the DVD lamp lights up on the unit.

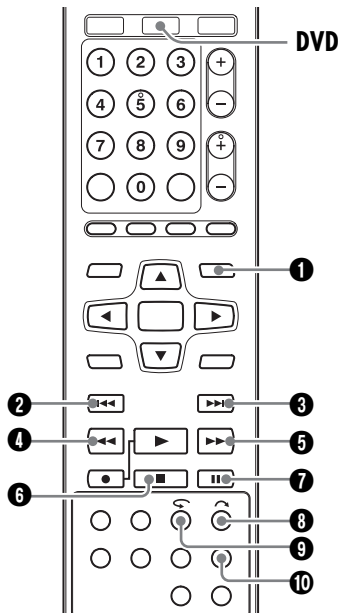

1 NAVIGATION

Displays Library Database DVD Navi menu. You can choose a title to play back.

2 ◀◀

- Pressing once skips back to the beginning of the chapter being played back.
- Pressing down for 2 or more seconds during playback reverses playback at 5 times the normal speed while pressed. Releasing the button resumes normal playback.

Available only when paused

- Pressing down for 2 or more seconds reverses playback at 1/16 times the normal speed.

3 ▶▶

- Pressing once skips forward to the beginning of the next chapter being played back.
- Pressing down for 2 or more seconds during playback advances playback at 5 times the normal speed while pressed. Releasing the button resumes normal playback.

Available only when paused

- Pressing down for 2 or more seconds advances playback at 1/16 times the normal speed.

4 ◀◀

- Each press of the button during playback advances the playback speed in 5 steps in the reverse direction.

Available only when paused

- Each press of the button reverses the still picture frame by frame.
- Pressing down for 2 or more seconds reverses playback at 1/16 times the normal speed. Then, each press of the button reverses slow-motion at 1/16 times, 1/4 times and 1/2 times the normal playback.

5 ▶▶

- Each press of the button during playback advances the playback speed in 4 steps in the forward direction.

Available only when paused

- Each press of the button advances the still picture frame by frame.
- Pressing down for 2 or more seconds advances playback at 1/16 times the normal speed. Then, each press of the button advances slow-motion at 1/16 times, 1/4 times and 1/2 times the normal playback.

6 ■

- Pressing once during Live Memory Playback returns to the screen on air.
- Pressing twice during recording stops recording and returns to the screen on air.

7 II

Pressing once pauses playback (still picture playback). Pressing repeatedly advances the still picture frame by frame.

8 ↷

Pressing once skips forward for approximately 30 seconds and resumes playback.

Pressing repeatedly skips forward continuously as many times as pressed.

It is useful when skipping over unwanted sections.

9 ↶

Pressing once skips back for approximately 30 seconds and resumes playback.

Pressing repeatedly skips back for approximately 7 seconds continuously as many times as pressed.

It is useful when watching sports programmes, etc.

10 LIVE CHECK

Pressing once displays the picture currently being recorded and the one being played back simultaneously.

Pressing successively clears the Live Check window and displays only the picture currently being played back.

You can check, for example, if the programme you are recording has already finished.

To Play Back From The Beginning Of The Programme While Recording

You can play back a programme you are recording from the beginning while continuing to record or timer record onto a DVD-RAM disc.

Press ▶. Live Memory Playback starts from the beginning of the programme being recorded.

- Pressing ◀◀ or ▶▶ allows you to locate the desired scenes.

To Move Back The Playback Position Slightly While Recording (One Touch Replay Function)

You can move back the playback position while continuing to record or timer record onto a DVD-RAM disc.

Press ↶.

- Each press skips back for approximately 7 seconds and resumes playback.
- Pressing while paused skips back for approximately 7 seconds and resumes pause.

To Watch A Programme Previously Recorded While Recording

You can play back a programme you recorded previously while recording.

1 Press ▶ during recording. Live Memory Playback starts.

2 Press ◀◀ or ▶▶ to locate the beginning of the desired programme.

NOTE:

To stop playback, press ■. The programme being recorded is displayed.

Using The On-screen Bar



The on-screen bar allows you to control various playback functions. Some of the functions operated on Navigation Menu can be controlled on the On-screen bar.

Be sure to clear Library Database DVD Navi screen by pressing **NAVIGATION**.

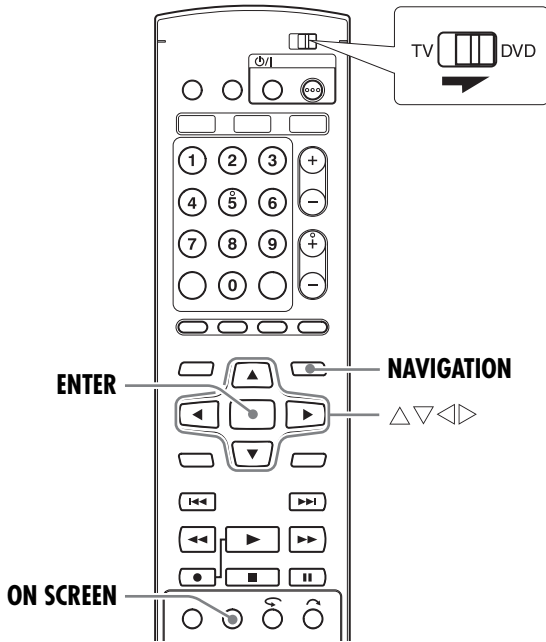

How To Access The On-screen Bar

1 Press **ON SCREEN** twice whenever a disc is loaded.

Contents of the on-screen bar during playback

DVD VIDEO

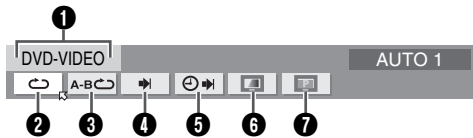

Video CD

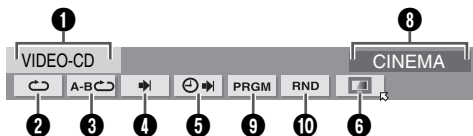

JPEG disc



- 1 Disc type.
- 2 Select this for Repeat Playback. (pg. 56)
- 3 Select this for A-B Repeat Playback. (pg. 56)
- 4 Select this for search function. (pg. 56)
- 5 Select this for time search function. (pg. 57)
- 6 Select this for Picture Control function. (pg. 57)
- 7 Select this to switch picture source type. (pg. 57)
- 8 Current status area for the selected item.
- 9 Select this for Programme Playback. (pg. 58)
- 10 Select this for Random Playback. (pg. 58)
- 11 Select this to control the switching interval of the slide show. (pg. 58)

NOTE:

Although examples of the on-screen bar are provided here only for 3 types of discs, the on-screen bar will be displayed for whichever disc indicated in the left column.

Basic Operation On The On-screen Bar

Example: When selecting Picture Control function of DVD

During playback or while stopped

1 Press **ON SCREEN** twice to access the on-screen bar. The item currently selected is highlighted and pointed by .



2 Press to select "", then press **ENTER**. The pop-up window appears under the selected item.



3 Press to select the desired option, then press **ENTER**.

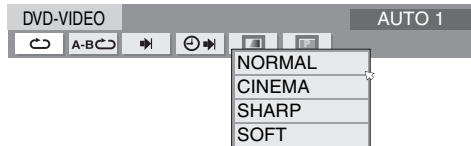

To clear the on-screen bar

Press **ON SCREEN**.

NOTE:

See the corresponding pages for details on each menu item.

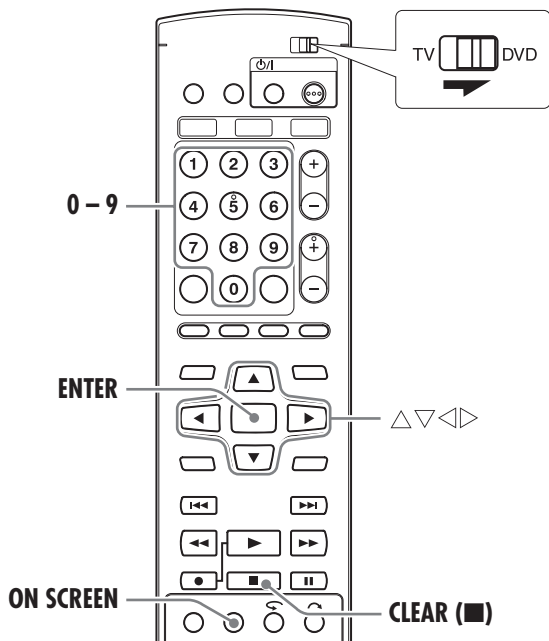

Repeat Playback



You can repeat playback as you like according to the type of disc.

- 1 Press **ON SCREEN** twice to access the on-screen bar.
- 2 Press $\triangleleft \triangleright$ to select "A-B", then press **ENTER**. The pop-up window appears under the selected item.



- 3 Press $\triangle \nabla$ repeatedly to select the desired Repeat mode, then press **ENTER**.

DVD-RAM/RW/R

OFF: Repeat playback is not performed.

ALL REPEAT: The whole disc is played back repeatedly.

TITLE REPEAT: The current title is played back repeatedly.

DVD VIDEO

OFF: Repeat playback is not performed.

TITLE REPEAT: The current title is played back repeatedly.

CHAPTER REPEAT: The current chapter is played back repeatedly.

Audio CD/Video CD/JPEG/MP3

OFF: Repeat playback is not performed.

ALL REPEAT: The whole disc is played back repeatedly.

TRACK REPEAT*: The current track is played back repeatedly.

* "TRACK REPEAT" cannot be selected for JPEG discs.

To clear the on-screen bar

Press **ON SCREEN**.

To cancel Repeat Playback

Repeat the above procedure from step 1, select "OFF" in step 3, then press **ENTER**.

NOTES:

- Repeat Playback is not possible for a Video CD with PBC function.
- Repeat Playback may not work properly depending on the type of the disc being used.

A-B Repeat Playback



You can repeat the desired part.

During playback

- 1 Press **ON SCREEN** twice to access the on-screen bar.
- 2 Press $\triangleleft \triangleright$ to select "A-B".
- 3 Press **ENTER** at the beginning of the desired part you want to repeat (point A). The elapsed playing time of the point A appears.



- 4 Press **ENTER** at the end of the desired part you want to repeat (point B). The elapsed playing time of the point B appears.

- The selected part of the disc (between point A and B) is played repeatedly.



To clear the on-screen bar

Press **ON SCREEN**.

To cancel A-B Repeat Playback

Press $\triangleleft \triangleright$ to select "A-B", then press **ENTER**.

NOTES:

- A-B Repeat Playback may not work properly depending on the type of disc being used.
- The subtitles recorded around the A-B point may not appear.
- When the end of the item is reached before the end point is set, the on-screen bar disappears from the TV screen. In such a case, repeat the procedure from step 1.
- The point B must be set at least 3 seconds after the point A.
- When playing back a DVD, A-B Repeat Playback is possible only within the same title.
- "A-B" cannot be selected during Programme and Random Playback.
- "A-B" cannot be selected while stopped.

Locating The Beginning Of A Desired Selection



You can locate the beginning of a title, chapter, group or track.

During playback or while stopped

- 1 Press **ON SCREEN** twice to access the on-screen bar.
 - 2 Press $\triangleleft \triangleright$ to select "▶", then press **ENTER**.
 - 3 Press $\triangle \nabla$ to select the desired item, then press **ENTER**.
- Skip this step for Video CD and Audio CD.

For DVD-RAM/RW/R, DVD VIDEO

"TITLE SEARCH" or "CHAPTER SEARCH" is selectable. ("TITLE SEARCH" is selectable only while stopped.)

For JPEG, MP3

"GROUP SEARCH" or "TRACK SEARCH" is selectable.

For Video CD, Audio CD

"TRACK" is selectable.



4 Press the **number buttons** to enter the desired item number, then press **ENTER**.

- Playback starts from the selected section.

Examples:

- 1 To select track 5, press the **number button** “5”.
- 2 To select track 15, press the **number button** “1” and “5”.
- 3 To select track 25, press the **number button** “2”, then “5”.

If you have specified a wrong selection

Press **CLEAR** (■) on the remote control unit and repeat the above procedures from step 2.

To clear the on-screen bar

Press **ON SCREEN**.

NOTES:

- When “0” is displayed on the TV screen in step 4, the chapter you have selected is not contained in the disc, or chapter search does not work on the disc.
- Before you press **ENTER**, playback may start automatically when you enter the section’s number depending on the disc.
- This function is not possible for a Video CD with PBC function.

Time Search



You can play back a disc from the desired point by specifying the elapsed playing time from the beginning of a programme (DVD-RAM, DVD-R, DVD-RW and DVD VIDEO) or a disc (Video CD and Audio CD).

- 1 Press **ON SCREEN** twice to access the on-screen bar.
- 2 Press < > to select “⌚▶”, then press **ENTER**. The pop-up window appears under the selected item.



- 3 Press the **number buttons** to enter the time, then press **ENTER**. Playback starts from the specified time.

Example:

To play back from a point 12 (minutes): 50 (seconds) elapsed.



If you have specified a wrong selection,

Press **CLEAR** (■) on the remote control unit and repeat the above procedures from step 2.

To clear the on-screen bar

Press **ON SCREEN**.

NOTES:

- When “0” is displayed on the TV screen in step 3, you have selected a point that exceeds the recording time of the disc.
- Some DVD VIDEO discs do not contain time information, and it is not possible to use the Time Search function. In such cases, “0” is displayed on the TV screen as well.
- This function is not possible for a Video CD with PBC function.

Adjusting The Picture Quality



You can obtain optimal picture quality by selecting an appropriate picture mode.

- 1 Press **ON SCREEN** twice to access the on-screen bar.
- 2 Press < > to select “🖥️”, then press **ENTER**. The pop-up window appears under the selected item.



- 3 Press < > to select the desired option, then press **ENTER**.
NORMAL: Normally select this option.
CINEMA: Suitable for a movie disc, etc.
SHARP: Clearer, sharper-edged picture when viewing images with lots of flat, same-coloured surfaces such as cartoons.
SOFT: Select this option when too much noise appears.

To clear the on-screen bar

Press **ON SCREEN**.

Setting The Progressive Mode



You can obtain optimal picture quality by selecting whether the content on the disc is processed by field (video source) or by frame (film source).

- 1 Set the unit to the progressive scan mode. (pg. 80)
- 2 Press **ON SCREEN** twice to access the on-screen bar.
- 3 Press < > to select “📺”, then press **ENTER**. The pop-up window appears under the selected item.



- 4 Press < > to select the desired option, then press **ENTER**.
AUTO 1: Used to play a disc containing both video and film source materials. This system recognises the source type (video or film) of the current disc according to the disc information. Normally select this option.
AUTO 2: Almost the same as the “AUTO 1”, but the processing of the scenes with movement is different. Select “AUTO 1” or “AUTO 2” to your preference.
FILM: Suitable for playing back a progressive scanned film source disc.
VIDEO: Suitable for playing back a video source disc. The outlines on the played back pictures will be soft.

To clear the on-screen bar

Press **ON SCREEN**.

NOTE:

When the progressive mode is set, be sure to set “L-1 OUTPUT” to “COMPONENT”. (pg. 44) Progressive scan is output only from [COMPONENT VIDEO OUT] connector.

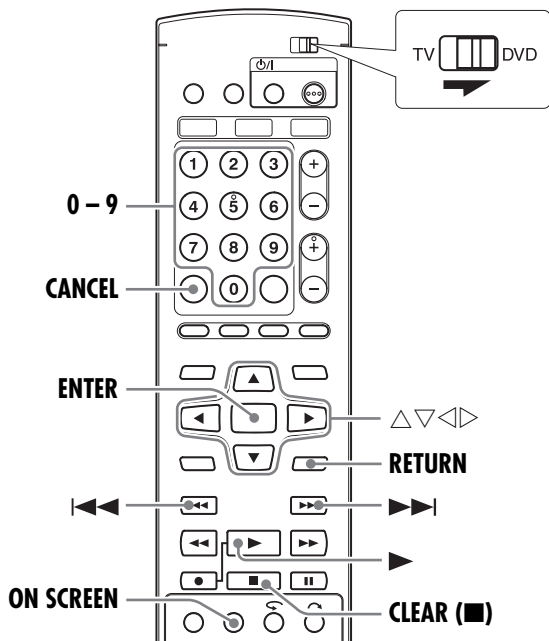

Programme Playback



You can programme up to 99 tracks (Video CD or Audio CD) to play back in the desired order.

While stopped

- 1 Press **ON SCREEN** twice to access the on-screen bar.
- 2 Press $\triangleleft \triangleright$ to select "PRGM", then press **ENTER**. The programme table appears under on-screen bar.



- 3 Press the **number buttons** to enter the track numbers in the desired order.

Examples:

- 1 To select track 5, press the **number button "5"** and **ENTER**.

- 2 To select track 15, press the **number button "1"** and **"5"**.
- 3 To select track 25, press the **number button "2"** and **"5"**.

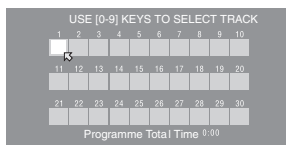

If you have specified a wrong selection

Press **CANCEL**. The last selection is erased.

Or press **CLEAR** (■). The whole selection is erased.

- 4 Press **▶**. Playback starts in the programmed order.
 - When all of the programmed tracks have been played back, Programme Playback stops, but the programmed information remains.
 - To add tracks to the end of the programme, perform steps 1 through 3.
 - During Programme Playback, pressing **▶▶** skips to the next selection of the programme. Pressing **◀◀** returns to the beginning of the current selection.

To clear the on-screen bar and the contents of the programme
Press **ON SCREEN**.

To cancel Programme Playback

Press $\triangleleft \triangleright$ to select "PRGM", then press **ENTER**.

NOTE:

Programme Playback is not possible depending on the type of disc.

Random Playback



You can play back all the tracks on the disc in random order.

While stopped

- 1 Press **ON SCREEN** twice to access the on-screen bar.
- 2 Press $\triangleleft \triangleright$ to select "RND", then press **ENTER**. Playback starts in random order.



To clear the on-screen bar

Press **ON SCREEN**.

To cancel Random Playback

Perform steps 1 and 2.

NOTE:

The same track will not be played back more than once during Random Playback.

Select The Switching Interval Of The Slide Show



You can control the switching interval of the slide show.

- 1 Press **ON SCREEN** twice to access the on-screen bar.
- 2 Press $\triangleleft \triangleright$ to select "☰", then press **ENTER**. The pop-up window appears under the selected item.

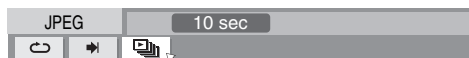

- 3 Press $\triangle \nabla$ to select the desired option, then press **ENTER**.
 - Each time you press $\triangle \nabla$, the interval changes as follows:
5 SEC. \leftrightarrow 10 SEC. \leftrightarrow 15 SEC. \leftrightarrow 20 SEC. \leftrightarrow 25 SEC. \leftrightarrow 30 SEC. \leftrightarrow (Back to the beginning)

To clear the on-screen bar

Press **ON SCREEN**.

NOTE:

JPEG files are played back as a slide show. It may take more time to display an image with larger file size.

Advanced Playback (VHS)

- Turn on the unit.
- Turn on the TV and select the AV mode.
- Slide the **TV/DVD** switch to **DVD**.
- Press **VHS** so that the VHS lamp lights up on the unit.

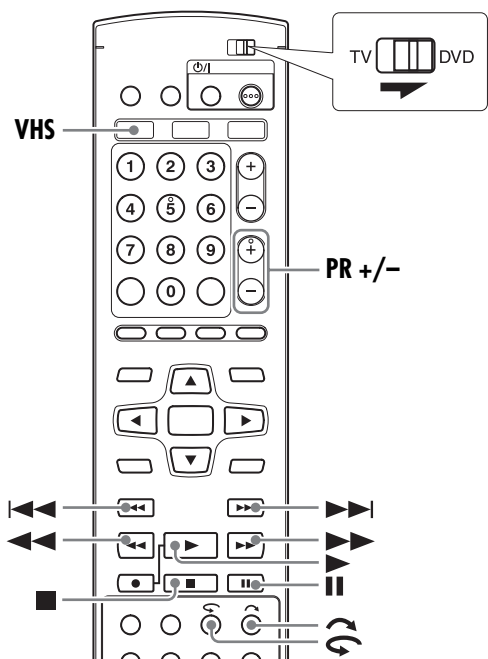

Clean the video heads using a dry cleaning cassette when:

- Rough, poor picture appears while a tape is played back.
- The picture is unclear or no picture appears.
- "USE CLEANING CASSETTE" appears on the screen (only with "SUPERIMPOSE" set to "AUTO"). (pg. 79)

NOTE:

The heads get dirty in the following cases:

- in an environment prone to extreme temperature or humidity
- in a dusty environment
- flaw, dirt or mold on video tapes
- continuous usage for a long time

ATTENTION:

- In the search, still, slow-motion or frame-by-frame playback mode,
- the picture will be distorted.
 - the noise bars will appear.
 - there may be a loss of colour.
 - you cannot hear the sound.

Still Picture/Frame-By-Frame Playback

- 1 Press **II** to pause during playback.
- If there is vertical jitter, press **PR +/-** to correct the picture.
- 2 Press **II** repeatedly to activate frame-by-frame playback.
- To resume normal playback, press **▶**.

Slow Motion

- 1 Press **II** to pause during playback.
- 2 Press and hold **II** for 2 seconds, then release. Press **II** and release again to return to still picture.
- The speed changes for each direction by pressing **◀◀** and **▶▶** repeatedly.
- To resume normal playback, press **▶**.

NOTE:

During slow motion playback, some noise may appear on the TV screen. Press **PR +** or **-** to eliminate the noises.

High-Speed Search

During playback, press **▶▶** for forward high-speed search, or **◀◀** for reverse high-speed search.

- Each press of the button increases the search speed for each direction.

When pressing **▶▶**:

(SP): +5x ↔ +7x

(LP): +11x ↔ +21x

When pressing **◀◀**:

Once **◀◀** is pressed, reverse search starts in -1x normal playback speed.

After this process, each press of **◀◀** changes the search speed between -5x and -7x in SP mode, -11x and -21x in LP mode.

(SP): -1x ↔ -5x ↔ -7x

(LP): -1x ↔ -11x ↔ -21x

- To resume normal playback, press **▶**.

Quick Rewind A Little

During playback, press **↶**. The unit rewinds the picture a little (about 7 seconds) and resumes playback.

- If the button is pressed repeatedly, the unit rewinds the pictures continuously and resumes playback.

Skip Search

During playback, press **↷** 1 to 6 times to skip over unwanted sections.

- Each press initiates an approximately 30-second period of fast-motion playback. Normal playback resumes automatically.
- To resume normal playback, press **▶**.

Index Search

Your unit automatically marks index codes at the beginning of each recording. This function gives you quick access to any one of the 9 index codes in either direction.

NOTE:

Before starting, make sure the unit is in the Stop mode.

Press **◀◀** or **▶▶** to activate Index Search. "◀◀ 1" or "▶▶ 1" is displayed on the TV screen and search begins in the corresponding direction.

- To access index codes 2 through 9, press **◀◀** or **▶▶** repeatedly until the correct index number is displayed.

Example:

To locate the beginning of B from the current position, press **◀◀** twice.

To locate the beginning of D from the current position, press **▶▶** once.

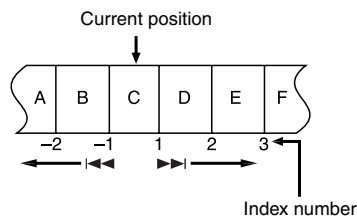

- When the specified index code is located, playback begins automatically.

Next Function Memory

The Next Function Memory "tells" the unit what to do after rewinding. Before continuing, make sure the unit is in the Stop mode.

For Automatic Start Of Playback

Press ◀◀, then press ▶ within 2 seconds.

For Automatic Cassette Ejection

Press ◀◀, then press ▲ (EJECT) within 2 seconds.

Repeat Playback

Your unit can automatically play back the whole tape 100 times repeatedly.

- 1 Press ▶ to start playback.
- 2 Press and hold ▶ for over 5 seconds, then release.
 - "C" lights up on the front display panel.
 - After playing back a tape 100 times, the unit stops automatically.
- 3 Press ■ at any time to stop Repeat Playback.
 - Pressing ▶, ◀◀, ▶▶ or || also stops Repeat Playback.

Manual Tracking

Your unit is equipped with automatic tracking control. During playback, you can override this and adjust the tracking manually by pressing the PR buttons.

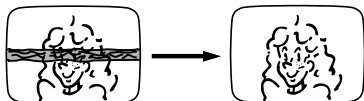

- 1 During playback, press PR + or – on the unit simultaneously to activate manual tracking.
- 2 Press PR + or – to adjust the tracking manually.
 - To return to automatic tracking, press PR + or – simultaneously or eject and insert the tape again.

NOTE:

When a new tape is inserted, the unit enters the automatic tracking mode automatically.

Soundtrack Selection

Your unit is capable of recording three soundtracks (HI-FI L, HI-FI R and NORM) and will play back the one you select.

During Playback

Pressing **AUDIO** changes the soundtrack as follows:

TRACK	USE
On-Screen Display	
HI FI L ▶ ◀ R	For Hi-Fi stereo tapes
HI FI L ▶	For main audio of Bilingual tapes
HI FI ◀ R	For sub audio of Bilingual tapes
NORM	For audio-dubbed tapes
HI FI NORM	For audio-dubbed tapes

NOTES:

- "HI FI L ▶ ◀ R" should normally be selected. In this mode, Hi-Fi stereo tapes are played back in stereo, and the normal audio track is played back automatically for tapes with only normal audio.
- For instructions on recording stereo and bilingual programmes, refer to page 64.
- "SUPERIMPOSE" must be set to "AUTO" or the on-screen displays will not appear. (pg. 79)

VHS Progressive Scan

You can watch the images on VHS deck in the Progressive scan mode via component video.

ATTENTION:

- Your TV needs to be compatible with Progressive and to have Component video input connectors.
- Make sure that there is no disc in the unit.

- 1 Set the Progressive-compatible TV to the component input mode.
- 2 Press DVD so that the DVD lamp lights up on the unit.
- 3 Press **PROGRESSIVE SCAN** for 3 or more seconds.
 - The video output indicator **P** lights up on the front display panel.
- 4 Press VHS so that the VHS lamp lights up on the unit, then press **PROGRESSIVE SCAN**.
 - "→" lights up on the unit.

NOTES:

- Be sure to engage the DVD deck in stop mode.
- During still picture in VHS Progressive Scan mode, the images may jitter, but this is not a malfunction.

Advanced Recording (DVD)



- Turn on the unit.
- Turn on the TV and select the AV mode.
- Slide the **TV/DVD** switch to **DVD**.
- Press **DVD** so that the DVD lamp lights up on the unit.

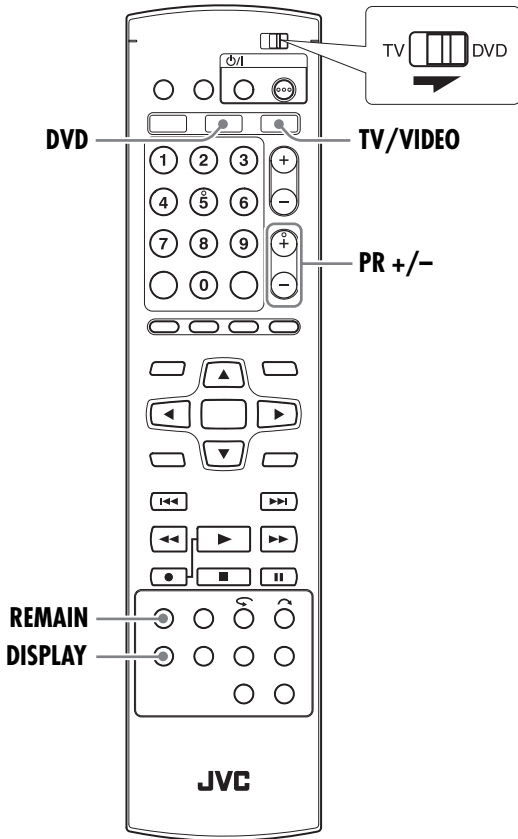
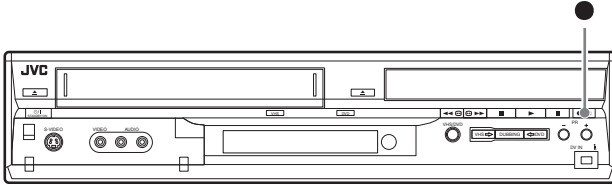

Instant Timer Recording (ITR)

This easy method lets you record for from 30 minutes to 6 hours (selectable in 30-minutes interval), and shuts the unit off after recording is finished.

- 1 Press ● on the unit to start recording.
- 2 Press ● again to engage the ITR mode.
 - On the front display panel, "0:30" appears.
- 3 If you want to record for more than 30 minutes, press ● to extend the time. Each press extends recording time by 30 minutes.

NOTE:

You can only perform ITR using the ● button on the unit.

Watch Another Programme While Recording On The Unit

While recording is going on, you can watch another programme on the TV by using the TV's tuner.

NOTE:

It is required that the remote control is set to be able to operate the TV in advance. (☞ pg. 75)

1 During recording, press **TV/VIDEO** to switch the TV's input mode so that the programme selected on the TV appears.

2 Slide the **TV/DVD** switch to **TV**.

3 Press **PR +/-** repeatedly to select the desired channel.

NOTE:

If a decoder is connected to the unit (☞ pg. 77), you can select a scrambled channel as well as other normal channels.

Elapsed Recording Time And Disc Remaining Time Indication

During recording, press **DISPLAY** repeatedly until the desired indication appears on the front display panel.

- Each time you press **DISPLAY**, the time indication changes as follows:
Elapsed recording time → Disc remaining time → Clock → (Back to the beginning)
- You can also check the disc remaining time by pressing **REMAIN** while the unit is stopped or recording is in progress. The list of disc remaining times for all recording modes appears on the TV screen.

Free Rate Function

To record the entire programme, the unit automatically sets the appropriate recording mode depending on the combination of the total time of the programme to be recorded and either the remaining disc space or the specified recording time (from 60 minutes to 480 minutes).

■ To record the entire programme within the actual remaining disc space

Select "FR (JUST)" in a recording mode selection procedure.

- Note that this function is available only for timer programming recording (☞ pg. 26, 29, 31).

■ To record the entire programme by specifying the desired recording time

Select "FR60–FR360", "FR420" or "FR480" in a recording mode selection procedure. (☞ pg. 26, 29, 31)

■ To record a 25-min. long daily programme five times just on the same DVD disc for example

Perform "SHOWVIEW™ Timer Programming" (☞ pg. 29) procedure. Be sure to set the recording mode to "FR125" and set Weekly/Daily Rec Function to "MON–FRI" in step 6 to fit the total recording time to the whole disc space.

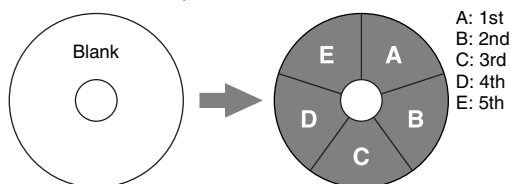

When the same programme is recorded in SP mode instead of in "FR125", the 5th programme cannot be recorded.

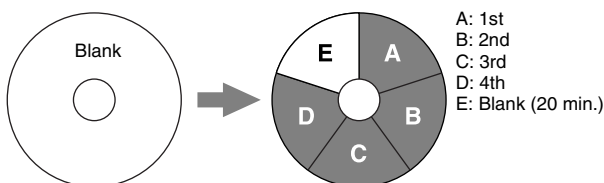

NOTES:

- You can programme this unit to timer-record, regardless of the disc remaining time. When the disc remaining time is not enough, recording may stop in the middle of a programme. To avoid this, make sure of the disc remaining time before setting timer programming. **(Example)** If you programmed to timer-record for 60 minutes in SP mode on a 120-minute disc, the disc remaining time would be 30 minutes in XP mode, 60 minutes in SP mode, 120 minutes in LP mode, 180 minutes in EP mode, and 240 minutes in FR480 mode. Timer-recording will not complete beyond these remaining times.
- The maximum recording time of "FR (JUST)" mode is the same as the recording time of FR480 mode. When timer programming a long programme in "FR (JUST)" mode on a disc whose remaining time is short, it is recommended to check the disc remaining time in FR480 mode to see if the remaining time is enough for the programme.
- Even if more than one programme are timer programmed in "FR (JUST)" mode, only the first one is recorded.
- In order to ensure that the recording fits on the disc, this feature may leave a slight non-recorded section at the end of the disc.
- There may be some noise and sound disturbance at the point on the disc where the unit switches the mode.

Receiving Stereo And Bilingual Programmes

Your unit is equipped with a Sound-Multiplex decoder (A2) and a Digital stereo sound decoder (NICAM) making reception of stereo and bilingual broadcasts possible.

When the channel is changed, the type of broadcast being received will be displayed on the TV screen for a few seconds.

Type of Broadcast Being Received	On-screen Display
A2 Stereo	
A2 Bilingual	
Regular Monaural	
NICAM Stereo	
NICAM Bilingual	
NICAM Monaural	

NOTES:

- "SUPERIMPOSE" must be set to "AUTO". Otherwise the on-screen displays will not appear. (☞ pg. 79)
- If the quality of stereo sound being received is poor, the broadcast might be received in monaural with better quality.

Selection Of The Audio Channel To Be Recorded On A Disc

When a programme is recorded on a DVD-RAM or DVD-RW disc in VR mode, all audio channels of the receiving programme are recorded on the disc. When you record a programme on a DVD-R or DVD-RW disc in video mode, select the desired audio channel (from among "NICAM 1/MAIN", "NICAM 2/SUB", "MONO") to be recorded on the disc. (☞ pg. 79)

NOTE:

Before playing back a programme recorded in stereo, or a bilingual programme, refer to "Audio Channel Selection" on page 50.

Advanced Recording (VHS)

- Turn on the unit.
- Turn on the TV and select the AV mode.
- Slide the **TV/DVD** switch to **DVD**.
- Press **VHS** so that the VHS lamp lights up on the unit.

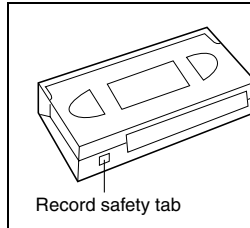
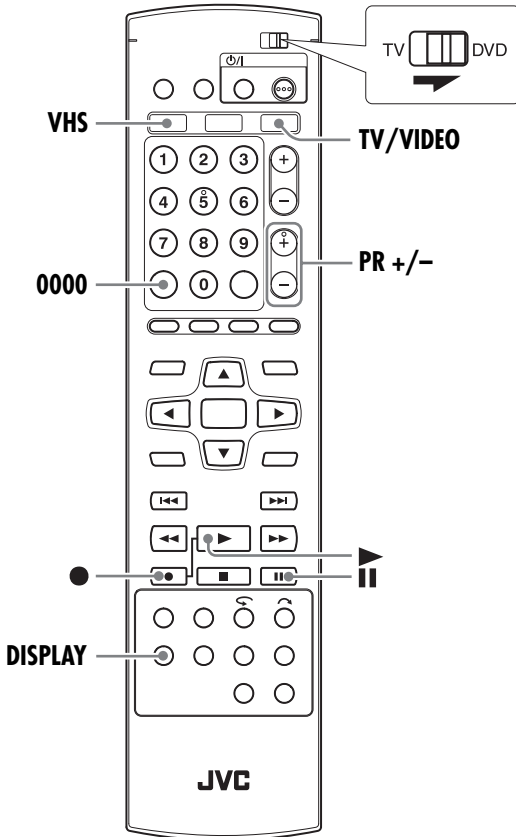
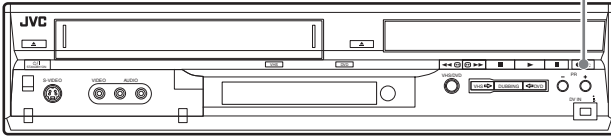

Accidental erasure prevention
To prevent accidental recording on a recorded cassette, remove its safety tab. To record on it later, cover the hole with adhesive tape.

Record safety tab

Watch Another Programme While Recording On The Unit

While recording is going on, you can watch another programme on the TV by using the TV's tuner.

NOTE:

It is required that the remote control is set to be able to operate the TV in advance. (pg. 75)

1 During recording, press **TV/VIDEO** to switch the TV's input mode so that the programme selected on the TV appears.

2 Slide the **TV/DVD** switch to **TV**.

3 Press **PR +/-** repeatedly to select the desired channel.

NOTE:

If a decoder is connected to the unit (pg. 77), you can select a scrambled channel as well as other normal channels.

Instant Timer Recording (ITR)

This easy method lets you record for from 30 minutes to 6 hours (selectable in 30-minutes interval), and shuts the unit off after recording is finished.

1 Press ● on the unit to start recording.

2 Press ● again to engage the ITR mode.

- On the front display panel, "0:30" appears.

3 If you want to record for more than 30 minutes, press ● to extend the time. Each press extends recording time by 30 minutes.

NOTES:

- You can only perform ITR using the ● button on the unit.
- During Instant Timer Recording, any other timer programmed recording won't start even if their start time has come. In such a case, the timer programmed recording starts (if the end time of the timer programmed recording is set after the end of Instant Timer Recording) after the Instant Timer Recording finishes.

Elapsed Recording Time Indication

1 Press **DISPLAY** until a counter reading appears on the front display panel.

2 Press **0000** to reset the counter before starting recording or playback.

- The counter is reset to "0:00:00" and shows the exact elapsed time as the tape runs. You can check the exact time of a recording or playback.

Tape Remaining Time

1 Press **DISPLAY** until the time remaining on the tape appears.

- By pressing the **DISPLAY** button, you can change display to show the clock time, counter reading or tape remaining time.

NOTE:

Depending on the type of tape being used, the tape remaining time reading may not appear right away, or is not correct.



“- -: -” may sometimes appear, or the display may blink on occasion.

Receiving Stereo And Bilingual Programmes

Your unit is equipped with a Sound-Multiplex decoder (A2) and a Digital stereo sound decoder (NICAM) making reception of stereo and bilingual broadcasts possible.

When the channel is changed, the type of broadcast being received will be displayed on the TV screen for a few seconds.

Type of Broadcast Being Received	On-screen Display
A2 Stereo	ST
A2 Bilingual	BIL.
Regular Monaural	(none)
NICAM Stereo	ST NICAM
NICAM Bilingual	BIL. NICAM
NICAM Monaural	NICAM

- To listen to a stereo programme, press **AUDIO** until “HI FI L  R” appears on the TV screen.
- To listen to a bilingual programme, press **AUDIO** until “HI FI L  R” or “HI FI  R” appears on the TV screen.
- To listen to the standard (Regular Monaural) audio while receiving a NICAM broadcast, press **AUDIO** until “NORM” appears on the TV screen.

NOTE:

“SUPERIMPOSE” must be set to “ON”, or the on-screen displays will not appear. (⇨ pg. 79)

To Record Stereo and Bilingual Programmes (A2)

Stereo programmes are automatically recorded in stereo on the Hi-Fi audio track (with the normal audio track recording mixed L and R channel sound).

- Bilingual programmes are automatically recorded in bilingual on the Hi-Fi audio track. The main soundtrack will be recorded on the normal audio track.

To Record NICAM Stereo and Bilingual Programmes

The NICAM audio programme will be recorded on the Hi-Fi audio track, and the standard audio programme will be recorded on the normal audio track.

NOTES:

- If the quality of stereo sound being received is poor, the broadcast will be received in monaural with better quality.
- Before playing back a programme recorded in stereo, or a bilingual programme, refer to “Soundtrack Selection” on page 60.

B.E.S.T. Picture System

The B.E.S.T. (Biconditional Equalised Signal Tracking) system checks the condition of the tape in use during playback and recording, and compensates to provide the highest-possible playback and recording pictures. You can set “B.E.S.T.” to “ON” or “OFF” to your preference. (⇨ pg. 81)

Playback

The unit assesses the quality of the tape once you initiate playback.



- The unit adjusts the playback picture quality based on the quality of the tape in use.
- B.E.S.T. is active during automatic tracking. “BEST” appears blinking on the front display panel.
- “BEST” only appears at the beginning of automatic tracking. Even though it doesn’t appear after that, the B.E.S.T. function is operative.



Recording

The unit assesses the quality of the tape once you initiate recording.

- The unit spends approximately 7 seconds assessing the condition of the tape, then begins recording.

ATTENTION:

Since the B.E.S.T. system works before recording actually starts, there is a delay of approximately 7 seconds after  and  on the remote control are pressed, or  on the unit is pressed. To make sure you record the desired scene or programme in its entirety, first perform the following steps:

1 Press and hold  and press  to engage the Record Pause mode.

- The unit then automatically checks the condition of the tape and, after approximately 7 seconds, re-enters Record Pause mode.

2 Press  to start recording.

If you want to bypass the B.E.S.T. system and begin recording immediately, set “B.E.S.T.” to “OFF”. (⇨ pg. 81)

Library Database DVD Navi



The Library Database DVD Navi enables you to search and select the desired titles recorded on a DVD-RAM/R/RW disc very easily. You can record up to 99 titles on a disc.

Each time a title is recorded on the disc, the information of the title is registered for the Library Database DVD Navi automatically. So, you can confirm the information of the titles recorded on the disc with the Library Database DVD Navi screen. And, you can also select one of the titles recorded using the Library Database DVD Navi.

The following screen appears as the Library Database DVD Navi screen when you press **NAVIGATION**. You can move the arrow to select the desired position on the screen by pressing Δ ∇ \triangleleft \triangleright on the remote control.

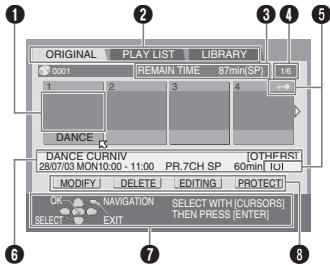

- 1 Index
(Small still picture of each title)
- 2 Names of functions
ORIGINAL (pg. 66)
PLAY LIST (pg. 68)
LIBRARY (pg. 71)
- 3 Remaining time
(Based on the recording mode currently selected)
- 4 Current/Total number of title(s)
(For example, there are 6 recorded titles and the title indicated by the arrow is the 3rd one.)
- 5 Icons
(Indicate the recording condition for each title.)
- 6 Recording information for the title indicated by the arrow
- 7 Guidance for operations
- 8 Operational commands

The Icons and their meanings

	This title is write-protected.
	This title has stereo sounds.
	This title has bilingual sounds.
	This title was recorded with timer recording.

Using Library Database DVD Navi system, you can easily modify registered information, edit the title or play list, as well as search for the beginning of each title.

About registration of information

The following information is automatically registered for each title when ordinary recording or timer recording is performed, then stored in an area specified on the unit.

- index* (reduced still pictures to show programme titles)
- programme title*
- category*
- date and time
- channel
- recording mode
- length of recording time

The items marked with an asterisk (*) can be easily modified and registered again after recording by using Library Database DVD Navi system.

About editing of titles

Library Database DVD Navi system has the following functions for editing of titles.

- "Modify Play List Information" (pg. 68)
- "Delete Title" (pg. 67)

The limitations of registration

You can register information up to 99 titles.

When the amount of information is at the limits of registration, you cannot record new title any more. In this case, you need to delete old titles to register new one. (pg. 67)

NOTE:

Once a DVD-R/RW (Video mode) disc has been finalised, the displays for original and play list do not appear. Only display for library appears.

The display for original recording

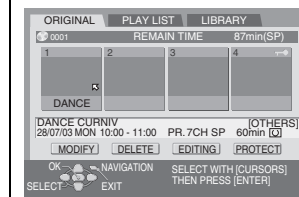

The display for play list



Scan For Beginning Of Title

- Turn on the TV and select the AV mode.
- Slide the **TV/DVD** switch to **DVD**.

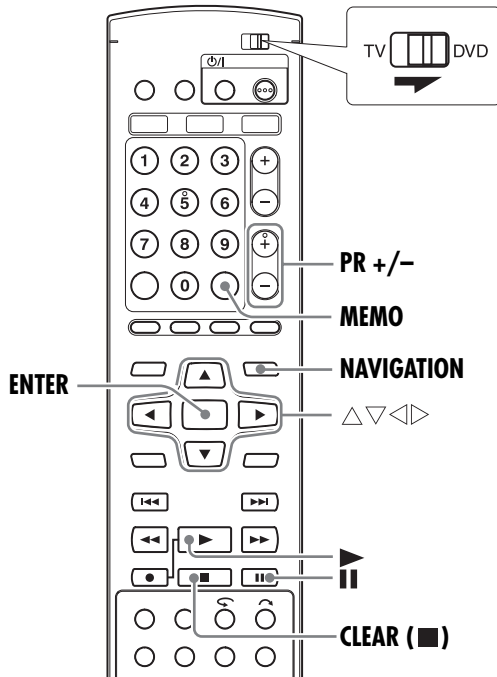

You can scan the beginning of the title easily with the Library Database DVD Navi.

- 1 Load a recorded disc.
- 2 Press **NAVIGATION**. The Library Database DVD Navi screen appears.
- 3 Press $\Delta \nabla \triangleleft \triangleright$ to select "ORIGINAL", then press **ENTER**.
- 4 Press $\triangleleft \triangleright$ to select the index (small still pictures) of the desired title.
 - You can press **PR +** or **-** to show other pages.
 - When you want the plural titles to be played back continuously, press **MEMO** after selecting the desired title. The numbers of the playback order appear on the index. You can select up to 30 titles.
 - When you want to correct the order, move the arrow to the desired index and press **MEMO**. The number disappears and the unit renumbers the other titles automatically.
 - When you want to cancel the order, press **CLEAR (■)**.
- 5 Press **ENTER** or \blacktriangleright to start playback.
- 6 Press **II** to pause playback.
 - To resume normal playback, press \blacktriangleright .
- 7 Press **■** to stop playback.

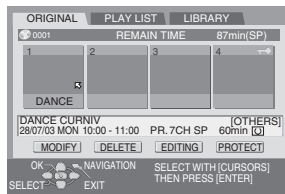

Modify Original Information



- Turn on the TV and select the AV mode.
- Slide the **TV/DVD** switch to **DVD**.

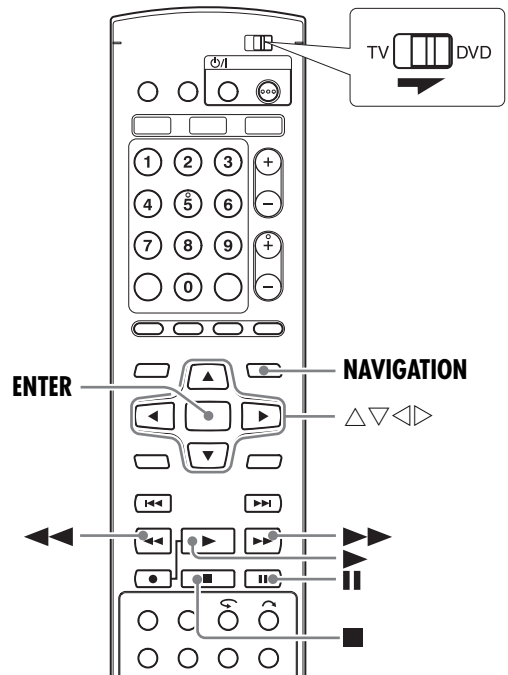

Modify Index

- 1 Press **NAVIGATION**. The Library Database DVD Navi screen appears.
- 2 Press $\Delta \nabla \triangleleft \triangleright$ to select "ORIGINAL", then press **ENTER**.
- 3 Press $\Delta \nabla \triangleleft \triangleright$ to select one title you want to modify, then press ∇ .
- 4 Press $\Delta \nabla \triangleleft \triangleright$ to select "MODIFY", then press **ENTER**.
- 5 Press $\triangleleft \triangleright$ to select "MODIFY INDEX".
- 6 Search for the picture from the title by pressing the appropriate buttons (\triangleleft , \blacktriangleright , $\blacktriangleright\blacktriangleright$, or **II**). The pictures of the title appear on the left window.
- 7 Confirm the arrow is on "REPLACE", then press **ENTER** to register new index. New index appears on the right window.
 - When you press **ENTER** with the arrow on "RETURN" you can return to the previous screen.
- 8 Press **NAVIGATION** to return to the normal screen.
 - Press **■** to cancel pause mode after pressing **NAVIGATION**.

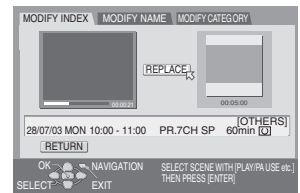

Modify Title Name

1 Perform steps **1** to **3** of "Modify Index" (pg. 66) before continuing.

2 Press $\Delta \nabla \triangleleft \triangleright$ to select "MODIFY", then press **ENTER**.

3 Press $\triangleleft \triangleright$ to select "MODIFY NAME".

4 Press $\Delta \nabla \triangleleft \triangleright$ to select the desired letter or command, then press **ENTER**. Repeat this process to complete the name.

- To correct a letter, press $\Delta \nabla \triangleleft \triangleright$ to select "DELETE" or "DELETE ALL", then press **ENTER**.

- You can enter the letters up to 64.

- You can also enter the new name with the **number buttons**. For example, when you press **2** repeatedly, "A", "B", "C", "a", "b", "c", "2", and then "A" appear by turns. You can use the following buttons.

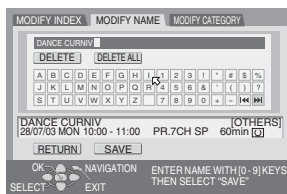

Number buttons: for entering letters, numbers and blank space

$\triangleleft \triangleright$ **buttons:** for moving the entering or inserting point

CLEAR (■) **button:** for correcting a letter

$\blacktriangleleft \blacktriangleright \blacktriangleright \blacktriangleleft$ **buttons:** for changing character tables

5 Press $\Delta \nabla \triangleleft \triangleright$ to select "SAVE", then press **ENTER**.

6 Press $\Delta \nabla \triangleleft \triangleright$ to select "RETURN", then press **ENTER**. The Library Database DVD Navi screen appears again.

7 Press **NAVIGATION** to return to the normal screen.

Modify Category

1 Perform steps **1** to **3** of "Modify Index" (pg. 66) before continuing.

2 Press $\Delta \nabla \triangleleft \triangleright$ to select "MODIFY", then press **ENTER**.

3 Press $\triangleleft \triangleright$ to select "MODIFY CATEGORY".

4 Press $\Delta \nabla \triangleleft \triangleright$ to select the desired category, then press **ENTER**.

5 Press **ENTER**. The Library Database DVD Navi screen appears again.

6 Press **NAVIGATION** to return to the normal screen.

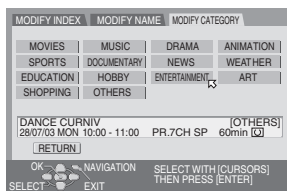

Protect Title

You can protect titles to prevent accidental erasure of the important titles.

1 Perform steps **1** to **2** of "Modify Index" (pg. 66) before continuing.

2 Press $\Delta \nabla \triangleleft \triangleright$ to select a title you want to protect, then press ∇ .

3 Press $\triangleleft \triangleright$ to select "PROTECT", then press **ENTER**. "🔑" appears.

- To cancel the protection, repeat **2** – **3** again.

4 Press **NAVIGATION** to return to the normal screen.

NOTE:

All the titles on a disc will be deleted once the disc is formatted even if they are protected titles. (pg. 67)

Delete Title

You cannot record any more with Library Database DVD Navi once the registered titles on the disc reach 99 titles. Deleting unnecessary titles after dubbing or other operations can increase remaining time and available recording capacity. (For DVD-R discs, although it is possible to delete recorded titles, available recording capacity does not increase.) The deleted title is never resumed. Play lists and programme information in the unit's library are also deleted.

1 Perform steps **1** to **2** of "Modify Index" (pg. 66) before continuing.

2 Press $\Delta \nabla \triangleleft \triangleright$ to select one title you want to delete, then press ∇ .

3 Press $\Delta \nabla \triangleleft \triangleright$ to select "DELETE", then press **ENTER**. The message appears for your confirmation.

4 Press $\triangleleft \triangleright$ to select "YES", then press **ENTER**.

- When you cancel the deletion, select "NO", then press **ENTER**.

5 Press **NAVIGATION** to return to the normal screen.

Delete Unwanted Part Of The Title

You can delete unwanted part of the title.

1 Perform steps **1** to **2** of "Modify Index" (pg. 66) before continuing.

2 Press $\triangleleft \triangleright$ to select one title whose unwanted part you want to delete, then press ∇ .

3 Press $\triangleleft \triangleright$ to select "EDITING", then press **ENTER**.

4 Press \blacktriangleright to start playback. The playback pictures appear in the window on the screen. The elapsed playing time starts counting with the arrow on "IN".

5 Find the point where you want the deletion to begin, then press **ENTER** with the arrow on "IN". The edit-in time is fixed and the elapsed playing time starts counting again.

6 Find the point where you want the deletion to end, then press **ENTER** with the arrow on "OUT". The edit-out time is fixed.

- Press \blacktriangleleft , \blacktriangleright , $\blacktriangleright \blacktriangleright$, $\blacktriangleleft \blacktriangleleft$, $\blacktriangleright \blacktriangleright \blacktriangleright$ or \parallel to find the edit-in and edit-out points.

7 Press $\Delta \nabla \triangleleft \triangleright$ to select "PREVIEW", then press **ENTER** to preview the edited title.

8 Press $\Delta \nabla \triangleleft \triangleright$ to select "EXECUTE", then press **ENTER**.

- If you do not want to delete the scene, select "CLEAR" and press **ENTER**.

9 Press $\triangleleft \triangleright$ to select "YES", then press **ENTER**. The selected scene is deleted.

- To cancel the deletion, press $\triangleleft \triangleright$ to select "NO", then press **ENTER**.

To modify the points

1 Press $\triangleleft \triangleright$ to select "CLEAR", then press **ENTER**.

2 Repeat steps **4** – **9** as necessary.

10 Press **NAVIGATION** to return to the normal screen.

NOTES:

- There may be a discrepancy of several seconds between the scene you intend to edit, and the scene which is actually edited.
- Available recording capacity may not match the deleted part after deletion.

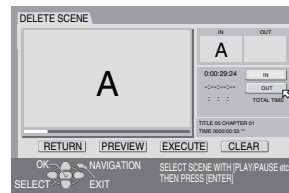

Modify Play List Information



- Turn on the TV and select the AV mode.
- Slide the TV/DVD switch to DVD.

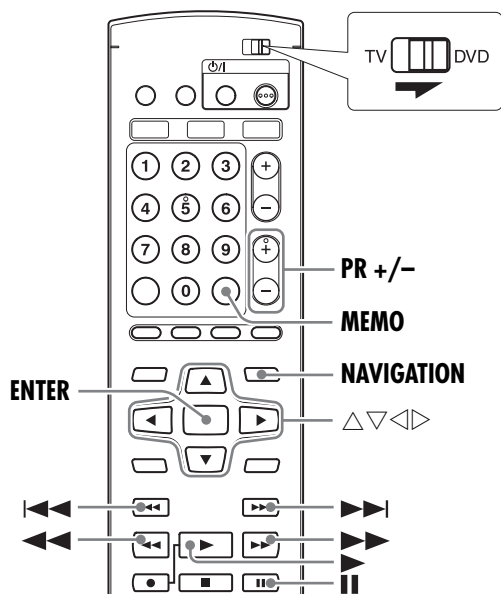

Play List

It is a collection of the scenes. A play list can be freely edited and played back without ever changing any original recording data. Using the random access of a DVD disc (which allows video data to be instantly read no matter where it is on the disc), a play list includes information such as the timer counter for the playback start point and end point, indexes for checking the contents of recorded data, category information, and more. Playback according to a play list you have created allows you to enjoy various combinations of video images from a single title.

Create Play List

- 1 Load a DVD-RAM or DVD-RW (VR mode) disc that was recorded with this unit.
- 2 Press **NAVIGATION**. The Library Database DVD Navi screen appears.
- 3 Press $\Delta \nabla \triangleleft \triangleright$ to select "PLAY LIST", then press ∇ or **ENTER**.
- 4 Press $\Delta \nabla \triangleleft \triangleright$ to select "CREATE", then press **ENTER**.
- 5 Press \blacktriangleright to start playback. The playback pictures appear in the window on the screen. The elapsed playing time starts counting with the arrow on "IN".
 - To locate the beginning of other titles, press $\blacktriangleleft \blacktriangleright$.
- 6 Find the point where you want the created play list to begin, then press **ENTER** with the arrow on "IN". The edit-in time is fixed and the elapsed playing time starts counting again.
- 7 Find the point where you want the created play list to end, then press **ENTER** with the arrow on "OUT". The edit-out time is fixed.
 - Press $\blacktriangleleft, \blacktriangleright, \blacktriangleright, \blacktriangleleft, \blacktriangleright$ or \parallel to find the edit-in and edit-out points.
 - The edit-out point must come after the edit-in point.

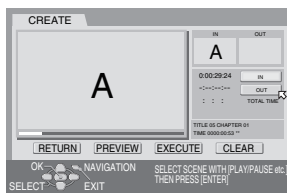

8 Press $\triangleleft \triangleright$ to select "PREVIEW", then press **ENTER** to preview the play list.

9 Press $\triangleleft \triangleright$ to select "EXECUTE", then press **ENTER**. The play list is created.

To modify the points

- 1 Press $\triangleleft \triangleright$ to select "CLEAR", then press **ENTER**.
- 2 Repeat steps 5 – 9 as necessary.

10 Press **NAVIGATION** to return to the normal screen.

NOTES:

- There may be a discrepancy of several seconds between the scene you intend to edit, and the scene which is actually edited.
- The title, index and category of the play list can be modified in the same way as "ORIGINAL". (pg. 66)
- You can modify the play list that has just been created here by adding, moving, or deleting unwanted parts to create a digest edition, etc.

Add Scenes To A Play List

1 Perform steps 1 to 3 of "Create Play List" (pg. 68) before continuing.

2 Press $\triangleleft \triangleright$ to select the play list to which you wish to add a scene, then press ∇ .

3 Press $\triangleleft \triangleright$ to select "EDITING", then press **ENTER**.

4 Press $\triangleleft \triangleright$ to select "ADD SCENE".

5 Press \blacktriangleright to start playback. The playback pictures appear in the window on the screen. The elapsed playing time starts counting with the arrow on "IN".

- To locate the beginning of other titles, press $\blacktriangleleft \blacktriangleright$.

6 Find the point where you want the added scene to begin, then press **ENTER** with the arrow on "IN". The edit-in time is fixed and the elapsed playing time starts counting again.

7 Find the point where you want the added scene to end, then press **ENTER** with the arrow on "OUT". The edit-out time is fixed.

- Press $\blacktriangleleft, \blacktriangleright, \blacktriangleright, \blacktriangleleft, \blacktriangleright$ or \parallel to find the edit-in and edit-out points.

8 Press $\triangleleft \triangleright$ to select "PREVIEW", then press **ENTER** to preview approximately 5 seconds before and after the edited scene.

9 Press $\triangleleft \triangleright$ to select "EXECUTE", then press **ENTER**. The selected scene is added.

To modify the points

- 1 Press $\triangleleft \triangleright$ to select "CLEAR", then press **ENTER**.
- 2 Repeat steps 5 – 9 as necessary.

10 Press **NAVIGATION** to return to the normal screen.

NOTE:

There may be a discrepancy of several seconds between the scene you intend to edit, and the scene which is actually edited.

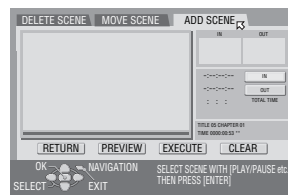

Move Scenes

- 1** Perform steps **1** to **3** of “Create Play List” (⇨ pg. 68) before continuing.
- 2** Press ◀▶ to select a play list into which you wish to move a scene, then press ▾.
- 3** Press ◀▶ to select “EDITING”, then press **ENTER**.

- 4** Press ◀▶ to select “MOVE SCENE”.
- 5** Press ▶ to start playback. The playback pictures appear in the window on the screen. The elapsed playing time starts counting with the arrow on “IN”.
 - To locate the beginning of other titles, press ◀◀▶▶.

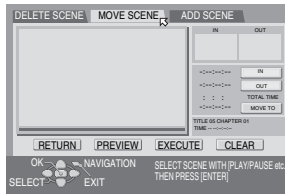

- 6** Find the point where you want the moved scene to begin, then press **ENTER** with the arrow on “IN”. The edit-in time is fixed and the elapsed playing time starts counting again.

- 7** Find the point where you want the moved scene to end, then press **ENTER** with the arrow on “OUT”. The edit-out time is fixed.

- 8** Press ▶ to start playback.

- 9** Find the point where you want the moved scene to be moved, then press **ENTER** with the arrow on “MOVE TO”.
 - Press ◀◀, ▶, ▶▶, ◀◀▶▶ or || to find the edit-in, edit-out and move-to points.

- 10** Press ◀▶ to select “PREVIEW”, then press **ENTER** to preview the part approximately 5 seconds before and after the point to which the scene has been moved.

- 11** Press ◀▶ to select “EXECUTE”, then press **ENTER**. The selected scene is moved.

To modify the points

- 1** Press ◀▶ to select “CLEAR”, then press **ENTER**.
- 2** Repeat steps **5** – **11** as necessary.

- 12** Press **NAVIGATION** to return to the normal screen.

NOTE:

There may be a discrepancy of several seconds between the scene you intend to edit, and the scene which is actually edited.

Delete Unwanted Part From Play List

- 1** Perform steps **1** to **3** of “Create Play List” (⇨ pg. 68) before continuing.
- 2** Press ◀▶ to select a play list from which you wish to delete unwanted parts, then press ▾.
- 3** Press ◀▶ to select “EDITING”, then press **ENTER**.

- 4** Press ◀▶ to select “DELETE SCENE”, then press **ENTER**.
- 5** Press ▶ to start playback. The playback pictures appear in the window on the screen. The elapsed playing time starts counting with the arrow on “IN”.
 - To locate the beginning of other titles, press ◀◀▶▶.

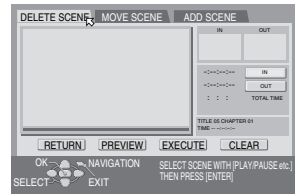

- 6** Find the point where you want the deletion to begin, then press **ENTER** with the arrow on “IN”. The edit-in time is fixed and the elapsed playing time starts counting again.

- 7** Find the point where you want the deletion to end, then press **ENTER** with the arrow on “OUT”. The edit-out time is fixed.

- Press ◀◀, ▶, ▶▶, ◀◀▶▶ or || to find the edit-in and edit-out points.

- 8** Press ◀▶ to select “PREVIEW”, then press **ENTER** to preview the scene approximately 5 seconds before and after the deleted part.

- 9** Press ◀▶ to select “EXECUTE”, then press **ENTER**. The selected scene is deleted.

To modify the points

- 1** Press ◀▶ to select “CLEAR”, then press **ENTER**.
- 2** Repeat steps **5** – **9**.

- 10** Press **NAVIGATION** to return to the normal screen.

NOTE:

There may be a discrepancy of several seconds between the scene you intend to edit, and the scene which is actually edited.

Play Back Play List

1 Perform steps **1** to **3** of “Create Play List” (pg. 68) before continuing.

2 Press $\triangleleft \triangleright$ to select the index (small still pictures) of the desired play list.

- You can press **PR +** or **-** to show other pages.

- When you want the plural play lists to be played back continuously, press **MEMO** after selecting the desired play lists.

The numbers of the playback order appear on the index. You can select up to 30 play lists.

- When you want to correct the order, move the arrow on the desired index and press **MEMO**. The number disappears and the unit re-numbers the other play lists automatically.

- When you want to cancel the order, press **CLEAR** (■).

3 Press **ENTER** or \blacktriangleright to start playback.

4 Press **II** to pause playback.

- To resume normal playback, press \blacktriangleright .

5 Press **■** to stop playback.

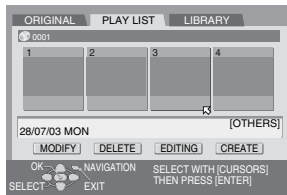

Delete Play List

1 Perform steps **1** to **3** of “Create Play List” (pg. 68) before continuing.

2 Press $\triangleleft \triangleright$ to select one play list you want to delete, then press ∇ .

3 Press $\triangleleft \triangleright$ to select “DELETE”, then press **ENTER**.

4 Press $\triangleleft \triangleright$ to select “YES”, then press **ENTER**.

- When you cancel the deletion, select “NO”, then press **ENTER**.

5 Press **NAVIGATION** to return to the normal screen.

NOTE:

Even if a play list is deleted, the titles recorded on a DVD disc and the library information are not affected at all.

Modify Index

1 Perform steps **1** to **3** of “Create Play List” (pg. 68) before continuing.

2 Perform steps **3** to **8** of “Modify Index” (pg. 66).

Modify Play List Name

1 Perform steps **1** to **3** of “Create Play List” (pg. 68) before continuing.

2 Press $\triangle \nabla \triangleleft \triangleright$ to select one title you want to modify, then press ∇ .

3 Perform steps **2** to **7** of “Modify Title Name” (pg. 67).

Modify Category

1 Perform steps **1** to **3** of “Create Play List” (pg. 68) before continuing.

2 Press $\triangle \nabla \triangleleft \triangleright$ to select one play list you want to modify, then press ∇ .

3 Perform steps **2** to **6** of “Modify Category” (pg. 67).

Modify Library Information

 DVD
RAM

 DVD
R

 DVD
RW

Title information can be registered in the unit's memory for up to 1,300 titles. It is helpful when finding out on which disc the desired programme is recorded.

- Turn on the TV and select the AV mode.
- Slide the TV/DVD switch to DVD.

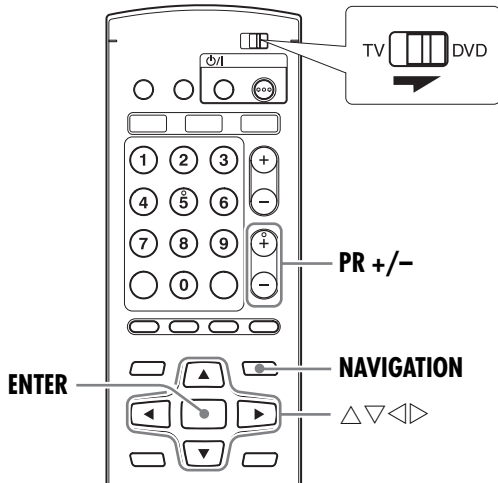

Scan For Title From Library

1 Press **NAVIGATION**. The Library Database DVD Navi screen appears.

2 Press $\Delta \nabla \triangleleft \triangleright$ to select "LIBRARY", then press **ENTER**.

3 Press $\triangleleft \triangleright$ to select the appropriate sort button to sort the information, then press **ENTER**.

"DISC No.": Sort by disc number

"CATEGORY": Sort by category

"DATE": Sort by date

"NAME": Sort by name

- The sorting order can be switched between ascending order and descending order by pressing the sort buttons.

4 Press $\triangleleft \triangleright$ to select the desired title, then press **ENTER**.

- You can press **PR +** or **-** to show other pages.

- Playback begins automatically after the selected title is located.

When the disc that contains the selected title is not loaded

A screen prompting you to load the designated disc appears. Place the disc whose number is displayed on the screen after pressing **ENTER** to close the prompt screen. Then perform steps 1 to 4.

NOTE:

If a disc registered in the library is recorded or modified on DVD units from other manufacturers, it may become impossible to operate properly.

Register Disc

1 Load a disc you want to register.

2 Press **NAVIGATION**. The Library Database DVD Navi screen appears.

3 Press $\Delta \nabla \triangleleft \triangleright$ to select "LIBRARY", then press **ENTER**.

4 Press $\triangleleft \triangleright$ to select "REGISTER", then press **ENTER**.

5 Press $\triangleleft \triangleright$ to select "REGISTER", then press **ENTER** to confirm the registration.

6 Press **NAVIGATION** to return to the normal screen.

NOTES:

- It is not possible to register discs used for On-Disc Timer Programming. (pg. 32)
- It is not possible to register discs formatted on devices other than JVC's DVD recorders.
- It is not possible to register discs recorded on devices other than JVC's DVD recorders.
- It is not possible to register discs when "SAVE AS LIBRARY" is set to "OFF". (pg. 79)

Delete Information

1 Press **NAVIGATION**. The Library Database DVD Navi screen appears.

2 Press $\Delta \nabla \triangleleft \triangleright$ to select "LIBRARY", then press **ENTER**.

3 Press $\Delta \nabla \triangleleft \triangleright$ to select the appropriate sort button to sort the information, then press **ENTER**.

4 Press $\triangleleft \triangleright$ to select a title you want to delete, then press ∇ .

5 Press $\Delta \nabla \triangleleft \triangleright$ to select "DELETE", then press **ENTER**.

6 Press $\triangleleft \triangleright$ to select "DELETE", then press **ENTER** to confirm the deletion.

7 Press **NAVIGATION** to return to the normal screen.

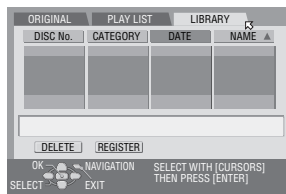

Playback With MP3/JPEG Navigation

MP3

JPEG

This unit can play back discs that MP3 sound files and JPEG image files taken with digital still cameras or other devices are recorded.

The MP3/JPEG Navigation enables you to search and select the desired files recorded on CD-R/RW or CD-ROM discs very easily.

The following screen appears as the MP3/JPEG Navigation screen when you press **NAVIGATION**. You can move the arrow to select the desired position on the screen by pressing $\triangle \nabla \triangleleft \triangleright$ on the remote control.

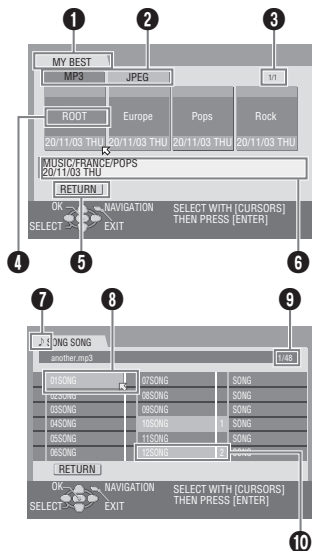

- 1 Name of the inserted disc.
- 2 Sort buttons ("MP3" / "JPEG")
- 3 Selected group number/total number of groups on the disc
- 4 Group name
- 5 Return button ("RETURN")
- 6 Group name/Created date
- 7 File type indicator
 J: MP3
 □: JPEG
- 8 Selected file
- 9 Selected file number/total number of files in the group that contains the selected file
- 10 Title number/file name

Locating The Desired Group And Tracks

- 1 Load a disc.
- 2 Press **NAVIGATION**. The MP3/JPEG Navigation screen appears.
- 3 **For MP3 Playback**
Press $\triangleleft \triangleright$ to select "MP3". Only groups which contain MP3 files appear.
- 4 **For JPEG Playback**
Press $\triangleleft \triangleright$ to select "JPEG". Only groups which contain JPEG files appear.
- 4 Press $\triangleleft \triangleright$ to select the desired group, then press **ENTER**.
 - For MP3 Playback**
 - The tracks in the selected group appear.
 - For JPEG Playback**
 - The images in the selected group appear.
- 5 Press $\triangle \nabla \triangleleft \triangleright$ to select the desired item, then press **ENTER**. The unit starts playback from the selected item.
 - The unit stops when all items in the selected group are played back.

NOTES:

- If you press \blacktriangleright instead of **ENTER** in step 4, the unit starts playback from the first file of the group.
- JPEG files are played back as a slide show at the set intervals. (☞ pg. 58)
- If a file name includes any 2-byte character, the unit may not show the file name correctly.
- Press $\triangle \nabla$ to select "RETURN", then press **ENTER** to return to the screen that shows the group(s).
- The order of the groups and items shown in steps 4 and 5 may differ from the order shown on your PC.

Programme Playback

- 1 Perform steps 1 to 4 of "Locating The Desired Group And Tracks" above before continuing.
- 2 Press $\triangle \nabla \triangleleft \triangleright$ to select the desired item, then press **MEMO** in the desired order.
 - The order number appears on the left of the track name.
 - Repeat this step as necessary.
 - To cancel the track, press $\triangle \nabla \triangleleft \triangleright$ to select the track, then press **CANCEL**.
 - Pressing **CLEAR** (■) clears all the order numbers.
- 3 Press \blacktriangleright to start playback.
 - To quit the Programme Playback, press ■.
 - Repeat playback can be performed if it is set as such on the on-screen bar. (☞ pg. 55)

NOTES:

- It is not possible to select tracks and images simultaneously.
- It is not possible to select tracks or images in other groups.

On completion of the playback of all the items

- 1 Perform steps 1 to 4 of "Locating The Desired Group And Tracks" above.
- 2 Press **CLEAR** (■).
 - The order numbers are reset and cleared.
- 3 Press **NAVIGATION** to complete the procedure.

Arrange your style

- Remote control setting** **74**
 How to change the code or how to operate your TV set with this remote control.
- For better sound** **77**
 Using Dolby Digital or DTS equipment
- It can be more useful by changing your settings!**
- For DVD operations**..... **78**
- For VHS operations** **81**
- Format** **89**
 Before you start recording on a new disc
- Finalise** **90**
 To play back a disc on other DVD players

Need help?

- Tips for your trouble** **91**
- Specifications** **95**
- Appendix – Language code list –** **96**
- Appendix – TV station and ID list –** **97**
- What do you want to know? – Terms –** **98**

Remote Control Functions

Remote Control 1/2/3/4 Code Switching

The remote control is capable of controlling four JVC video units independently. Each of the units can respond to one of four codes (1, 2, 3 or 4). The remote control is preset to send 3 code signals because your unit is initially set to respond to 3 code signals. You can easily modify your unit to respond to 1, 2 or 4 code signals.

- Slide the **TV/DVD** switch to **DVD**.

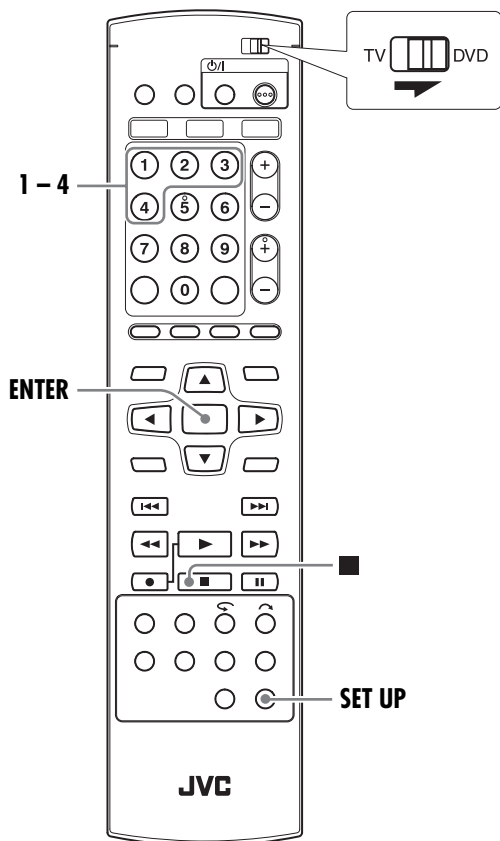
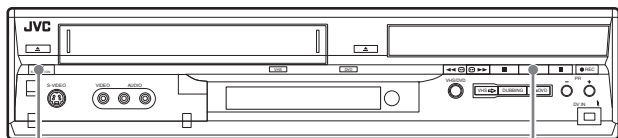

- Keep pressing **SET UP** down during step 1.

1 Press the **number button** “1” for 1, “2” for 2, “3” for 3 or “4” for 4 to change the remote control code, then press **ENTER**.

2 Press ϕ/I on the unit to turn off the unit.

3 Press \blacktriangleright on the unit for over 5 seconds while the unit is turned off. The code currently set appears on the front display panel.

4 Press \blacksquare on the remote control to change the unit's code. The code currently set on the remote control blinks on the front display panel for approximately 5 seconds, and is applied to the unit.

NOTE:

Even when “POWER SAVE” is set to “ON” (pg. 79), it is possible to change the remote code.

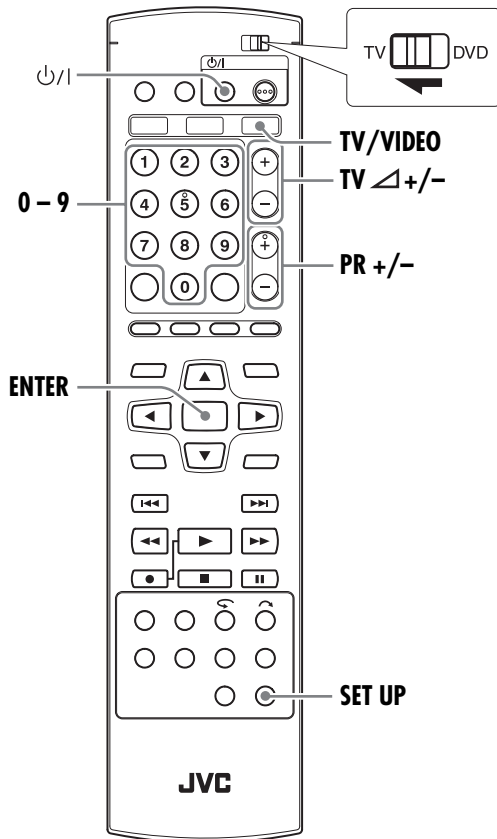

TV Multi-Brand Remote Control

Your remote control can operate the basic functions of your TV set. In addition to JVC TVs, other manufacturer's TVs can also be controlled.

- Turn off the TV using its remote control.
- Slide the **TV/DVD** switch to **TV**.

IMPORTANT:

Although the provided remote control unit is compatible with JVC televisions, as well as many other models, it may not work with your TV, or in some instances, may have limited function capability.

- Keep pressing **SET UP** down during step 1.

1 Enter your TV's brand code using the **number buttons**, then press **ENTER**.

2 Press **⏻** on the unit's remote control to turn on the TV and try operations (→ step 3).

- Once you have set the remote control to operate the TV, you do not have to repeat this step until you replace your remote control's batteries.
- Some brands of TVs have more than one code. If the TV does not function with one code, try entering another.

3 Press the corresponding buttons to operate the TV: **⏻**, **TV/VIDEO**, **PR +/-**, **TV +/-**, **number buttons**.

- For some brands of TVs, you must press **ENTER** after having pressed the **number buttons**.

BRAND NAME	CODE
JVC	01, 03
HITACHI	10
MAGNAVOX	02
mitsubishi	03
PANASONIC	04, 11
RCA	05
SHARP	06
SONY	07
SAMSUNG	12
SANYO	13
SEARS	13
TOSHIBA	08
ZENITH	09

Connecting To A Satellite Receiver

Simple Connections

This is an example of a simple connection if your TV has one 21-pin AV input (SCART) connector.

Connect the satellite receiver to the [L-2 IN/DECODER] connector, then connect the [L-1 IN/OUT] connector to the TV's connector.

NOTES:

- Set "L-2 SELECT" to "VIDEO/RGB" or "S-VIDEO/RGB". (☞ pg. 45)
- You can use the Automatic Satellite Programme Recording function (☞ pg. 36) with this connection. (DVD deck only)
- To record a programme via the satellite receiver, select L-2 mode by pressing **PR +/-** so that "L-2" appears on the front display panel.
- For details, refer to the instruction manual of the satellite receiver.

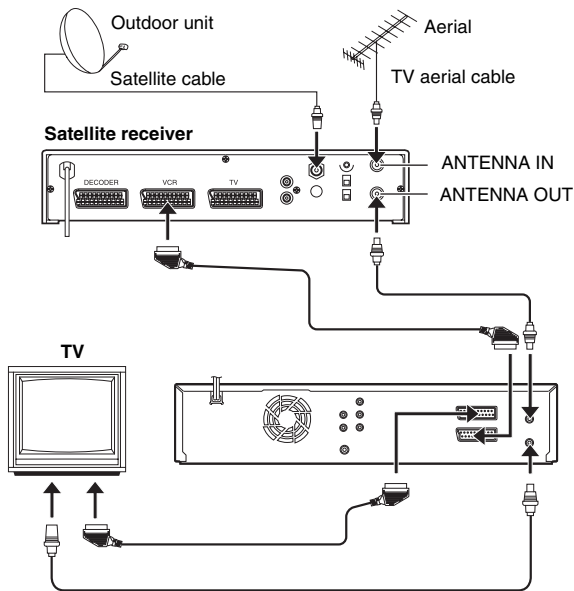

IMPORTANT

When you set "L-2 SELECT" to "SAT VIDEO/RGB" (☞ pg. 45), it is possible to view a satellite broadcast with the TV set to its AV mode even if the unit is turned off. When the unit is in Stop mode or recording, press **TV/VIDEO** on the remote control to turn off the video indicator (⊖➔) on the unit.

- If you turn on the unit when the satellite receiver's power is off, nothing appears on the TV screen. In this case, turn on the satellite receiver, or set the TV to its TV mode, or press **TV/VIDEO** on the remote control to set the unit to the AV mode.

Perfect Connections (Recommended)

This is an example of recommended connections if your TV has two 21-pin AV input (SCART) connectors.

Connect the decoder to the satellite receiver's connector if you have a decoder, [L-1 IN/OUT] connector to TV's connector, and [L-2 IN/DECODER] connector to the satellite receiver's connector. Then connect the satellite receiver and TV.

NOTES:

- Set "L-2 SELECT" to "VIDEO/RGB" or "S-VIDEO/RGB". (☞ pg. 45)
- You can use the Automatic Satellite Programme Recording function (☞ pg. 36) with this connection. (DVD deck only)
- To record a programme via the satellite receiver, select L-2 mode by pressing **PR +/-** so that "L-2" appears on the front display panel.
- To receive a scrambled broadcast, descramble the signal with the decoder connected to the satellite receiver.
- For details, refer to the instruction manual of the satellite receiver and decoder.

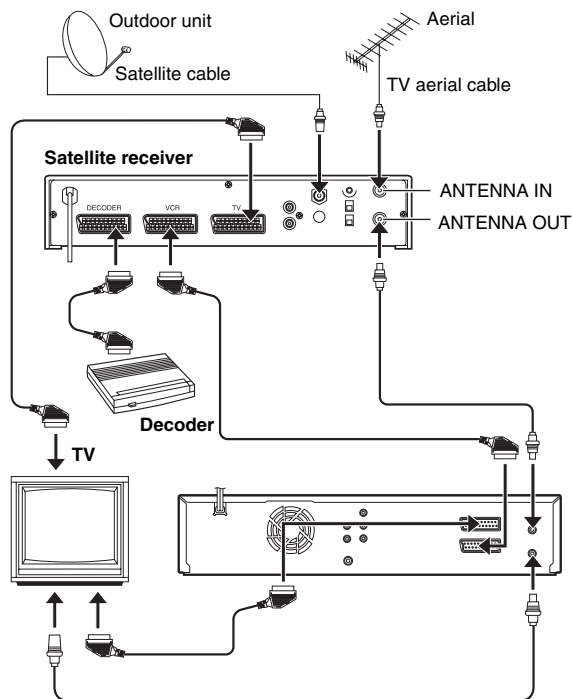

Connecting To A Dolby Digital Decoder Or An Amplifier With Built-in DTS

These instructions enable you to connect your unit to a Dolby Digital Decoder or an amplifier with built-in DTS.

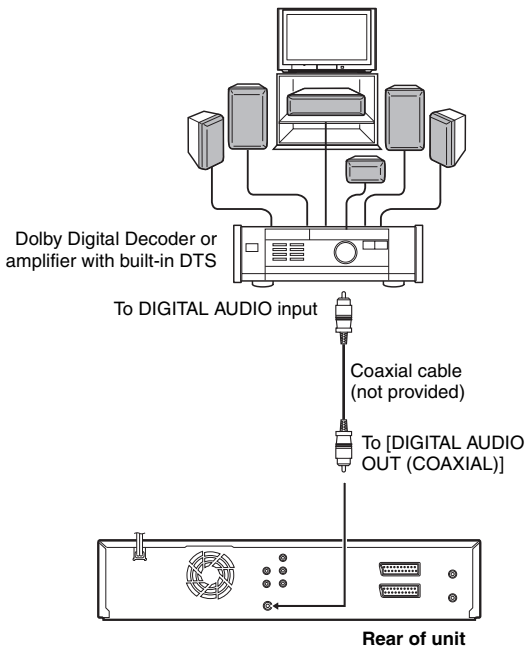

1 Connect the unit and a Dolby Digital Decoder or an amplifier with built-in DTS using an optional coaxial cable.

NOTES:

- For Dolby Digital sound, set "DIGITAL AUDIO OUT" to "DOLBY DIGITAL/PCM". (☞ pg. 78)
- For DTS sound, set "DIGITAL AUDIO OUT" to "STREAM/PCM". (☞ pg. 78)

CAUTIONS:

- This unit has a dynamic range of more than 110 dB with regards to its Hi-Fi audio capability. It is recommended that you check the maximum level if you are going to listen to the Hi-Fi audio signals through a stereo amplifier. A sudden surge in the input level to the speakers may damage them.
- Some speakers and televisions are specially shielded to prevent television interference. If both are of the non-shielded type, do not place the speakers adjacent to the TV set as this can adversely affect the playback picture.

When you can't switch the audio channel of a bilingual programme

When the unit is connected with a digital audio device using an optional coaxial cable and "DIGITAL AUDIO OUT" is set to "DOLBY DIGITAL/PCM", it is not possible to switch the audio channel of a bilingual programme recorded on a DVD-RAM or DVD-RW (VR mode) disc. In this case, perform the following steps using the remote control to switch "DIGITAL AUDIO OUT" from "DOLBY DIGITAL/PCM" to "PCM ONLY".

- 1 Press **SET UP** to access the Main Menu screen.
- 2 Press $\triangleleft \triangleright$ to select "DVD SET UP", then press ∇ .
- 3 Press $\triangleleft \triangleright$ to select "AUDIO OUTPUT", then press ∇ .
- 4 Press $\triangle \nabla$ to select "DIGITAL AUDIO OUT", then press **ENTER**.
- 5 Press $\triangle \nabla$ to select "PCM ONLY", then press **ENTER**. (☞ pg. 78)
- 6 Press **SET UP** to complete the setting.
- 7 Press **AUDIO** to select the desired audio channel. (☞ pg. 50)

Connecting/Using A Decoder (DVD Deck Only)

The [L-2 IN/DECODER] connector can be used as an input connector for an external decoder (descrambler). Simply connect a decoder and you can enjoy a variety of programming that is available through scrambled channels.

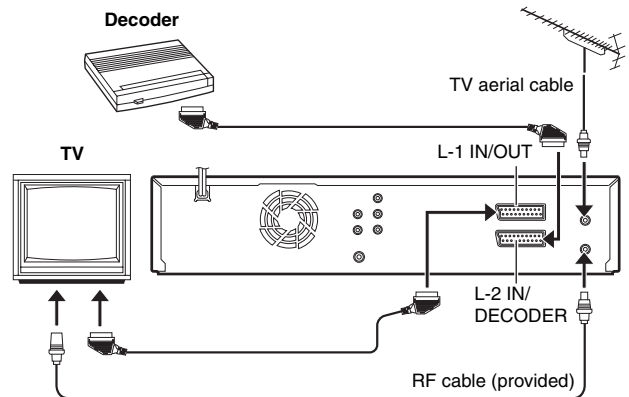

- 1 Set "L-2 SELECT" to "DECODER". (☞ pg. 45)
- 2 Connect your unit's [L-2 IN/DECODER] connector to the decoder's 21-pin SCART connector using a 21-pin SCART cable.
- 3 Perform the procedure as described in "When Receiving A Scrambled Broadcast (DVD Deck Only)" (☞ pg. 87). (DVD deck only)

Mode Set (DVD Deck)

- Turn on the unit.
- Turn on the TV and select the AV mode.
- Slide the **TV/DVD** switch to **DVD**.

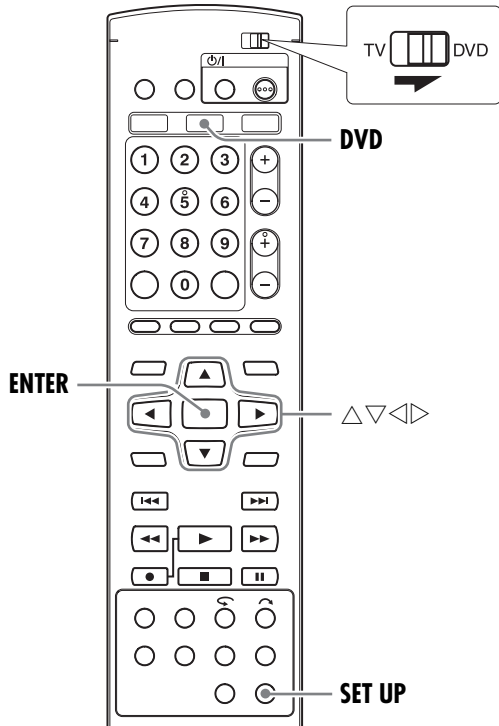

Various modes of this unit are categorised into menus nested in 2 levels shown in the following table. To change the settings of these modes, find the desired mode in the menu (for details on each menu, see pages 78 through 80), then follow the procedure below.

DVD SET UP	LANGUAGE SET (☞ pg. 20) AUDIO OUTPUT (☞ pg. 78) UTILITY (☞ pg. 89, 90)
FUNCTION SET UP	VIDEO IN/OUT (☞ pg. 21, 44) RECORDING SET (☞ pg. 79) DISPLAY SET (☞ pg. 79) OTHERS (☞ pg. 80)
INITIAL SET UP	AUTO CH SET (☞ pg. 84) MANUAL CH SET (☞ pg. 85) GUIDE PR (☞ pg. 83) CLOCK SET (☞ pg. 88)

- The procedure below shows how to set the desired option of the "AUDIO REC" mode as an example.

- 1 Press **DVD** so that the DVD lamp lights up on the unit.
- 2 Press **SET UP** to access the Main Menu screen.
- 3 Press $\triangleleft \triangleright$ to select "FUNCTION SET UP", then press ∇ .
- 4 Press $\triangleleft \triangleright$ to select "RECORDING SET", then press ∇ .
- 5 Press $\triangle \nabla$ to select "AUDIO REC", then press **ENTER**.
- 6 Press $\triangle \nabla$ to select the desired option, then press **ENTER**.
- 7 Press **SET UP** to complete the setting.

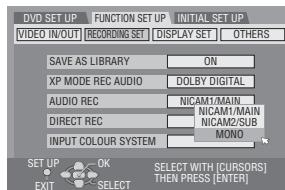

* The **boldface** settings below indicate the settings at your purchase.

AUDIO OUTPUT

■ DIGITAL AUDIO OUT — DOLBY DIGITAL / PCM / **STREAM / PCM / PCM ONLY**

Set to the appropriate mode according to the type of the device connected to [DIGITAL AUDIO OUTPUT] connector.

DOLBY DIGITAL/PCM: Select this when you connect the digital input connector of a Dolby Digital Decoder or an amplifier with a built-in Dolby Digital Decoder.

STREAM/PCM: Select this when you connect the digital input connector of an amplifier with a built-in DTS, Dolby Digital, or MPEG multichannel decoder.

PCM ONLY: Select this when you connect the linear PCM digital input of other audio equipment (amplifier, MD or DAT deck, etc.).

NOTE:

If you watch or play back a title which contains multiple audio languages, select "PCM ONLY" in advance and choose main or sub audio with **AUDIO**.

■ ANALOG AUDIO OUT — **STEREO / DOLBY SURROUND**

Select the appropriate setting to accommodate the unit to the connected A/V equipment. This function takes effect when a DVD VIDEO disc is played back.

STEREO: Select this when listening to conventional two-channel stereo audio with the unit's [AUDIO OUTPUT] connectors connected to a stereo amplifier/receiver or TV set, or in case you want to record the audio from a DVD VIDEO disc to a Mini Disc, etc.

DOLBY SURROUND: Select this when listening to multichannel surround audio with the unit's [AUDIO OUTPUT] connectors connected to an amplifier/receiver with a built-in surround decoder or a surround decoder.

■ **D. RANGE CONTROL — NORMAL / WIDE RANGE / TV MODE**

The dynamic range (the difference between the loudest sound and the quietest one) can be compressed during playback of a programme encoded in Dolby Digital format.

This function takes effect when a DVD VIDEO disc recorded in Dolby Digital format is played back at low or middle volume.

NORMAL: Normally select this setting to activate this function.

WIDE RANGE: Select this to deactivate this function when you enjoy wide dynamic range programme.

TV MODE: Select this when you hear the sound through the TV's speaker(s).

NOTES:

- This function has no effect on programmes other than that recorded in Dolby Digital format.
- The effect of "NORMAL" and "WIDE RANGE" may not be different depending on discs.

■ **OUTPUT LEVEL — STANDARD / LOW**

You can lower the output level of analog audio to accommodate the unit to the connected A/V equipment.

STANDARD: Normally select this setting.

LOW: The output level of analog audio is lowered.

RECORDING SET

■ SAVE AS LIBRARY — OFF / ON

When this function is set to "ON", the recording information is automatically stored in the library. For details, refer to "Modify Library Information" (☞ pg. 71).

■ XP MODE REC AUDIO — DOLBY DIGITAL / LINEAR PCM

You can select the audio format when you record a title in XP mode. When this function is set to "LINEAR PCM", you can obtain a high-quality audio sound.

DOLBY DIGITAL: To record in Dolby Digital format.

LINEAR PCM: To record in Linear PCM format.

■ AUDIO REC — NICAM 1/MAIN / NICAM 2/SUB / MONO

You can select the desired NICAM audio channel to be recorded on a DVD-R/RW (Video mode) disc.

NICAM 1/MAIN: To record the main language of NICAM audio.

NICAM 2/SUB: To record the sub language of NICAM audio.

MONO: To record the standard (monaural) sound of NICAM audio.

NOTE:

This function works only for the NICAM bilingual programme.

■ DIRECT REC — OFF / ON

When this function is set to "ON", you can easily start recording the programme that you are watching on your TV. Press and hold ● and press ► on the remote control, or press ● on the unit.

NOTES:

- When you use the Direct Rec function, be sure to use a TV offering T-V LINK, etc. and connect a fully-wired 21-pin SCART cable between the unit and the TV. (☞ pg. 15)
- If "DIRECT REC" is set to "OFF", the ● button functions as described in "Basic Recording (DVD)" (☞ pg. 26) or "Basic Recording (VHS)" (☞ pg. 28).
- During Direct Rec, "--" appears on the front display panel.
- If a programme is recorded with the Direct Rec, the station name will not be registered in the library. "-- --" will be displayed for the station name.
- Even if there is no power supply for more than 60 minutes, the unit keeps the setting.

■ INPUT COLOUR SYSTEM — AUTO / PAL / SECAM

You can play back PAL discs, or record PAL and SECAM signals on this unit. Select the appropriate colour system.

AUTO: Normally select "AUTO". "AUTO" identifies the input signal and automatically switches to an appropriate colour system.

When "AUTO" is not selected, you have to switch the colour system to an appropriate setting (PAL or SECAM) manually.

PAL: To record PAL signals.

SECAM: To record SECAM signals.

DISPLAY SET

■ SUPERIMPOSE — OFF / AUTO

When this function is set to "AUTO", various operational indicators appear on the TV screen. Messages appear in the selected language. (☞ pg. 20)

OFF: To turn off superimposed indications.

AUTO: To superimpose operational indications for approximately five seconds just after the corresponding operation.

NOTES:

- Even when "SUPERIMPOSE" is set to "OFF", you can display the various operational indicators by pressing **ON SCREEN**. To clear the operational indicators, press **ON SCREEN** again.
- When you use this unit as the source player for editing, be sure to set "SUPERIMPOSE" to "OFF" before starting.
- When you select "AUTO", during playback, the operation mode indicators may be disturbed depending on the type of disc being used.

■ GREY/BLUE BACK — OFF / ON

When this function is set to "ON", the TV screen becomes all grey (DVD deck)/blue (VHS deck) when receiving a channel not in use.

NOTE:

When you want to receive an unstable channel with poor signals, set this function to "OFF".

■ DIMMER — BRIGHT / DIMMED1 / DIMMED2 / OFF

You can change the brightness of the front display panel.

BRIGHT: To turn on the light on the front display panel. (Blue lamp on the front display panel is turned on.)

DIMMED1/DIMMED2: To change the brightness level. (Blue lamp on the front display panel is turned off.)

OFF: To turn off the light on the front display panel. (Blue lamp on the front display panel is turned off.)

■ POWER SAVE — OFF / ON

When this function is set to "ON", you can reduce the power consumption while the unit is turned off.

- During Power Save mode —
 - the front display panel will be turned off.
 - the Just Clock function (☞ pg. 88) does not work.
- Power Save does not work when —
 - the unit is in the Timer mode.
 - the unit's power is turned off after timer-recording or Instant Timer Recording.
 - the Automatic Satellite Programme Recording mode is engaged. (☞ pg. 36)
 - "L-2 SELECT" is set to "DECODER" or "SAT VIDEO/RGB". (☞ pg. 45)
- It takes some time for the unit to complete initialisation after you turn on the unit power, with "HELLO" blinking on the front display panel.

■ ON SCREEN LANGUAGE

This unit offers you the choice to view on-screen messages in 10 different languages. Though Auto Set Up selects the language automatically (☞ pg. 19), you can change the language setting manually as required.

For details, refer to "On-screen Language Set (DVD Deck Only)" (☞ pg. 20).

OTHERS

■ RESUME — OFF / ON / DISC RESUME

When this function is set to "ON" or "DISC RESUME", you can use the resume function. (☞ pg. 48)

OFF: You cannot use the resume function.

ON: You can start playback from the resume point of the placed disc.

DISC RESUME: The unit retains a memory of the resume points of the last 30 discs played back, even though they have been ejected.

NOTE:

"DISC RESUME" setting works on DVD VIDEO, VCD and already finalised DVD-R/DVD-RW (video mode) discs. For other types of discs, the function under "ON" setting will be applied even if "RESUME" is set to "DISC RESUME".

■ AUTO POWER OFF — OFF / 3H

When this function is set to "3H", the unit is turned off automatically if no operation is done with 3 hours.

Scan Mode Set

If you connect the unit and TV with Component Video Connection (☞ pg. 15), you can select the scan mode from two modes:

Interlaced scan mode which is used in the conventional TV system, and Progressive scan mode which enables reproduction of higher-quality images.

■ Interlaced scan

In the conventional video system, a picture is shown on the display monitor in two halves. The Interlaced scan system places lines of the second half of the picture in-between lines of the first half of the picture.

■ Progressive scan

Progressive scan displays all the horizontal lines of a picture at one time, as a single frame. This system can convert the interlaced video from DVD into progressive format for connection to a progressive display. It dramatically increases the vertical resolution.

ATTENTION:

- Your TV needs to be compatible with Progressive.
- Make sure that there is no disc in the unit.

- Turn on the unit.
- Turn on the TV and select the AV mode.
- Slide the TV/DVD switch to DVD.

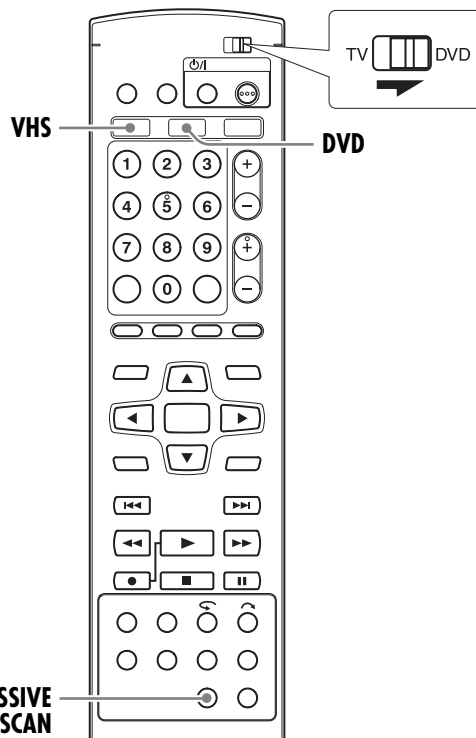

1 Press DVD so that the DVD lamp lights up on the unit.

2 Press **PROGRESSIVE SCAN** for 3 or more seconds.

- Video output indicator (P) lights up on the front display panel if Progressive scan mode has been established. (☞ pg. 14)
- Each press of **PROGRESSIVE SCAN** for 3 or more seconds switches the scan mode.

NOTES:

- When the progressive mode is set, be sure to set "L-1 OUTPUT" to "COMPONENT". (☞ pg. 44) Progressive scan is output only from [COMPONENT VIDEO OUT] connector.
- Interlaced scan mode is the setting at your purchase.
- Interlaced scan mode might be suitable depending on video material.
- Scan mode cannot be set while menu screen is displayed.
- When the Progressive scan mode is engaged, no video signal is output from [L-1 IN/OUT] connector.

Watch the images on VHS deck in the Progressive scan mode via component video

1 Set the Progressive-compatible TV to the component input mode.

2 Press DVD so that the DVD lamp lights up on the unit.

3 Press **PROGRESSIVE SCAN** for 3 or more seconds.

- The video output indicator (P) lights up on the front display panel.

4 Press VHS so that the VHS lamp lights up on the unit, then press **PROGRESSIVE SCAN**.

- "→" lights up on the unit.

NOTES:

- Be sure to engage the DVD deck in stop mode.
- During still picture in VHS Progressive Scan mode, the images may jitter, but this is not a malfunction.

Mode Set (VHS Deck)

- Turn on the unit.
- Turn on the TV and select the AV mode.
- Slide the TV/DVD switch to DVD.

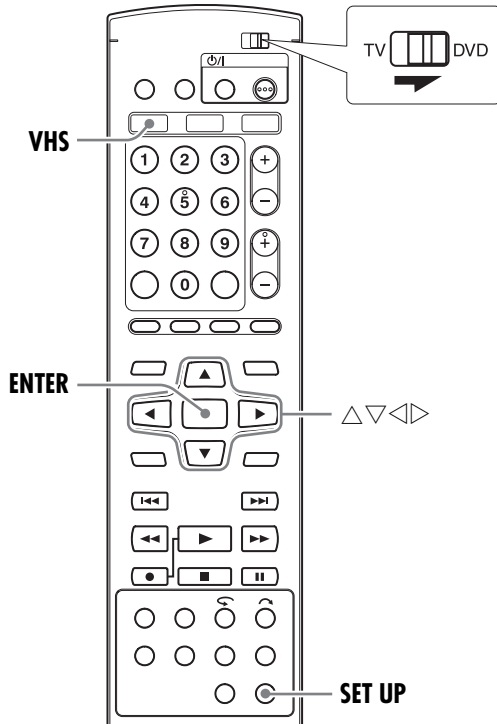

Various modes of this unit are categorised into menus nested in 2 levels shown in the following table. To change the settings of these modes, find the desired mode in the menu (for details on each menu, see pages 81 through 82), then follow the procedure below.

VHS SET UP	(pg. 81 – 82)
FUNCTION SET UP*	VIDEO IN/OUT (pg. 21, 44) RECORDING SET (pg. 79) DISPLAY SET (pg. 79) OTHERS (pg. 80)
INITIAL SET UP*	AUTO CH SET (pg. 84) MANUAL CH SET (pg. 85) GUIDE PR (pg. 83) CLOCK SET (pg. 88)

- The procedure below shows how to set the desired option of the "B.E.S.T." mode as an example.

- 1 Press **VHS** so that the VHS lamp lights up on the unit.
- 2 Press **SET UP** to access the Main Menu screen.
- 3 Press $\triangle \triangleright$ to select "VHS SET UP", then press ∇ .
- 4 Press $\triangle \nabla$ to select "B.E.S.T.", then press **ENTER**.
- 5 Press $\triangle \nabla$ to select the desired option, then press **ENTER**.
- 6 Press **SET UP** to complete the setting.

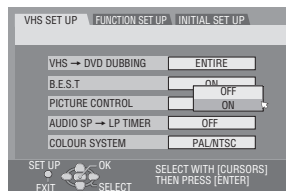

* The **boldface** settings below indicate the settings at your purchase.

■ VHS→DVD DUBBING — 1 PROG / ENTIRE

Set to the appropriate mode when you perform the dubbing from VHS tape to DVD disc. For details, refer to pages 37 – 38.

1 PROG: Dubbing stops when the unit decodes the index code (VISS signal).

ENTIRE: Dubbing stops when the end of the tape reached.

■ B.E.S.T. — ON / OFF

You can set the B.E.S.T. (Biconditional Equalised Signal Tracking) system to "ON" or "OFF".

NOTES:

- When watching a tape recorded with "B.E.S.T." set to "ON", it is recommended that you leave B.E.S.T. on during playback as well.
- When watching a rental tape or one recorded on another video recorder, or when using this unit as the player for editing, set B.E.S.T. to your preference.
- The B.E.S.T. system works for both SP and LP modes only after a tape has been inserted and the Record mode is first initiated. It does not work during recording.
- The B.E.S.T. system does not work while Automatic Satellite Programme Recording is in progress. (pg. 36)
- In the case of timer recordings, the B.E.S.T. system works before recording is initiated.
- Once the cassette is ejected, the B.E.S.T. data is cancelled. The next time the cassette is used for recording, B.E.S.T. is re-performed.
- Pressing the unit's **●** button while "BEST" is displayed does not start Instant Timer Recording. (pg. 61)

■ PICTURE CONTROL — AUTO (NORM) / EDIT / SOFT

This feature helps you to adjust the playback picture quality according to your preference. Normally select "AUTO (NORM)".

AUTO (NORM): Picture quality is adjusted automatically.

EDIT: Minimises picture degradation during editing (recording and playback).

SOFT: Reduces image coarseness when viewing overlaid tapes containing a lot of noise.

NOTES:

- When you select "EDIT" or "SOFT", the selected mode will not change until you select another mode.
- When you select "EDIT" to dub tapes, be sure to select "AUTO (NORM)" after you finish dubbing the tapes.
- When "B.E.S.T." is "OFF", "PICTURE CONTROL" switches automatically from "AUTO" to "NORM".

AUTO SP→LP TIMER — ON / OFF

When this function is set to “ON”, the unit automatically switches to LP mode to allow complete recording if there is not enough tape to record the entire programme while timer-recording in SP mode.

For Example:

Recording a programme of 140 minutes in length onto a 120-minute tape.

Approximately 100 minutes	Approximately 40 minutes
SP mode	LP mode
Total 140 minutes	

Make sure you set this function to “ON”, before the timer-recording starts.

NOTES:

- If you have programmed the unit to timer-record 2 or more programmes, the second programme and those thereafter may not fit on the tape if you set “AUTO SP→LP TIMER” to “ON”. In this case, make sure the mode is not engaged, then set the tape speed manually during timer programming.
- In order to ensure that the recording fits on the tape, this feature may leave a slight non-recorded section at the end of the tape.
- There may be some noise and sound disturbance at the point on the tape where the unit switches from SP to LP mode.
- The “AUTO SP→LP TIMER” feature is not available during ITR (Instant Timer Recording), and the feature will not work properly on the following tapes: T(ST)-30, T(ST)-60, T(ST)-90, and T(ST)-120.

COLOUR SYSTEM — PAL/NTSC / MESECAM

You can play back PAL, NTSC and MESECAM tapes, or record PAL and SECAM* signals on this unit. Select the appropriate colour system.

* SECAM signals will be recorded as MESECAM on this unit; MESECAM is the designation for tapes with SECAM signals that have been recorded on a MESECAM-compatible PAL video cassette recorder.

PAL/NTSC: To record PAL signals, or play back a PAL or NTSC tape.

MESECAM: To record SECAM signals, or play back a MESECAM tape.

NOTES:**About NTSC Playback**

- Some TVs shrink the picture vertically and place black bars at the top and bottom of the TV screen. This is not a malfunction on the part of either the unit or the TV.
- The picture may roll up and down. This can be corrected using the V-HOLD control found on some TVs. (This cannot be corrected if the TV does not have a V-HOLD control.)
- The counter and tape remaining time readings will be incorrect.
- During search, still, or frame-by-frame playback, the picture will be distorted, and there may be a loss of colour.
- Depending on the type of TV, the top and bottom portions of superimposed displays may be cut off during NTSC playback.

Tray Lock (DVD Deck Only)

You can lock the disc tray to prohibit the unwanted disc ejection by children.

- Turn off the unit.

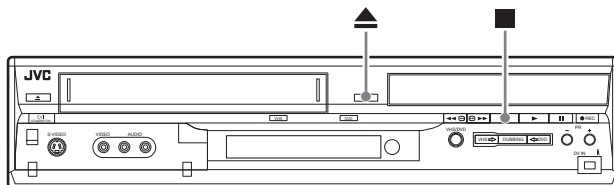
**To lock tray**

While the unit is turned off, press and hold ■, then press ▲ (OPEN/CLOSE) on the unit. “LOCK” appears on the front display panel and the disc tray is locked.

To unlock tray

While the unit is turned off, press and hold ■, then press ▲ (OPEN/CLOSE) on the unit. “UNLOCK” appears on the front display panel.

SHOWVIEW™ System Setup

IMPORTANT:

Normally, Auto Set Up (pg. 17), Preset Download (pg. 18) or Auto Channel Set (pg. 84) sets the Guide Program numbers automatically. You need to set the Guide Program numbers manually only in the following cases.

- When timer-programming with the SHOWVIEW system, the channel position, where the station you wish to record is received on your unit, is not selected, **OR** when you add a channel after Auto Set Up, Preset Download or Auto Channel Set has taken place, —Set the Guide Program number for that station manually.
- When you wish to timer-record a satellite programme with the SHOWVIEW system, —Set the Guide Program numbers for all satellite broadcasts received on your satellite receiver.

- Turn on the unit.
- Turn on the TV and select the AV mode.
- Slide the TV/DVD switch to DVD.

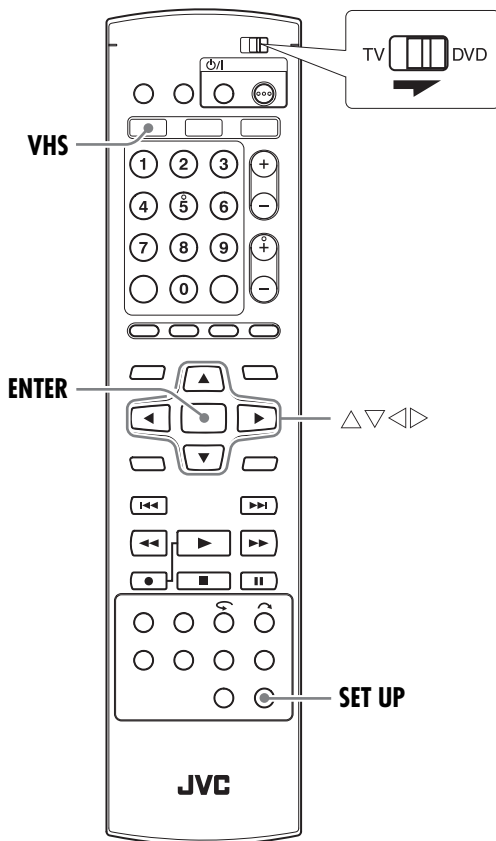

Guide Program Number Set

- Press **SET UP** to access the Main Menu screen.
- Press $\triangleleft \triangleright$ to select "INITIAL SET UP", then press ∇ .
- Press $\triangleleft \triangleright$ to select "GUIDE PR", then press ∇ .
- Press $\triangle \nabla$ to select "GUIDE PROGRAMME", then press **ENTER**.
- Press $\triangle \nabla$ to select the Guide Program number for the desired station as shown in the TV listings. Then press **ENTER**.
 - To change the Guide Program number in 10 increments, press and hold $\triangle \nabla$.
- Press $\triangle \nabla$ to select "TV PROGRAMME", then press **ENTER**.
- Press $\triangle \nabla$ to select the number of the unit's channel position on which the Guide Program number's broadcast is received by the unit or the satellite receiver. Then press **ENTER**.
 - If the satellite broadcast is received on your unit's auxiliary channel "L-2", select "L-2" for the channel position.
 - Repeat steps 4 and 7 as necessary.
- Press **SET UP** to complete the setting.

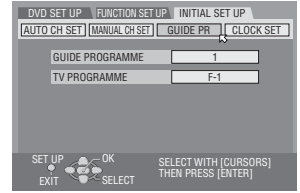

Guide Program Number

"Guide Program (GUIDE PROGRAMME) number" refers to the assigned TV station numbers, according to broadcast area, for the SHOWVIEW timer recording. The Guide Program numbers can be found in most TV listings.

Tuner Set

Your unit needs to memorise all necessary stations in channel positions in order to record TV programmes. Auto Channel Set automatically assigns all receivable stations in your area to call them up by using the **PR +/-** buttons without going through any vacant channels.

- Turn on the unit.
- Turn on the TV and select the AV mode.
- Slide the **TV/DVD** switch to **DVD**.

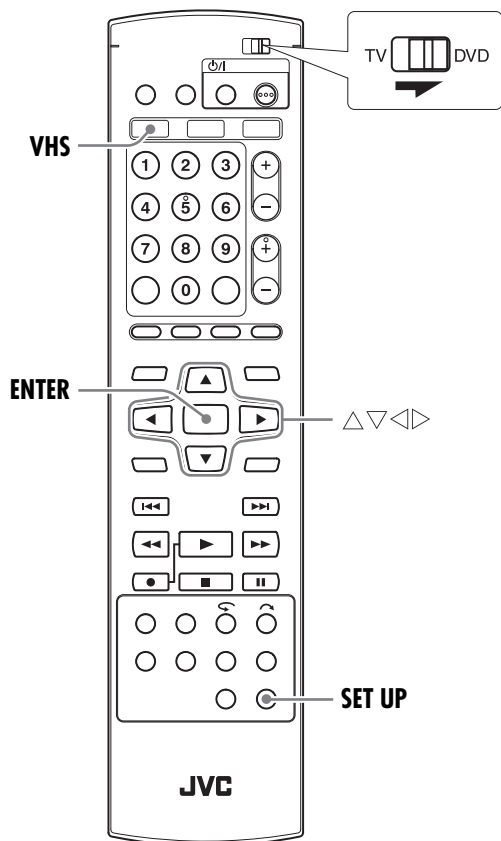

IMPORTANT:

Perform the following steps only if —
 — Auto Channel Set has not been set correctly by Auto Set Up or by Preset Download. (☞ pg. 17, 18)
 — you have moved to a different area or if a new station starts broadcasting in your area.

Auto Channel Set

- 1 Press **SET UP** to access the Main Menu screen.
- 2 Press $\triangleleft \triangleright$ to select "INITIAL SET UP", then press ∇ .
- 3 Press $\triangleleft \triangleright$ to select "AUTO CH SET", then press ∇ .
- 4 Press $\triangle \nabla \triangleleft \triangleright$ to select your country's name, then press **ENTER**.
- 5 Press $\triangle \nabla \triangleleft \triangleright$ to select the language of your choice.
- 6 Press **ENTER** twice.

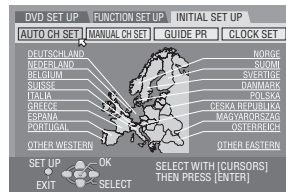

- 6 Press **ENTER** twice.
 - When you have connected the unit to a TV offering T-V Link via a fully-wired 21-pin SCART cable (☞ pg. 15), the unit automatically performs the Preset Download and the T-V LINK screen will appear. (☞ pg. 18)
 - The Auto Set screen appears, and remains on screen while the unit searches for receivable stations. Wait until the TV screen as shown in step 7 appears.
- 7 View the Confirmation screen. "SCAN COMPLETED" is displayed on the TV screen. Press "OK".
- 8 Press **SET UP** to complete the setting.
 - When Auto Channel Set is completed, "PLEASE WAIT" will be displayed for about 90 seconds, since channel data is exchanged between the DVD deck and the VHS deck. No operations will be done during this time.
 - Using the Confirmation screen, you can skip or add channel positions, enter station names and perform other operations. Refer to pages 85 – 87 for the procedures.
 - Depending on reception conditions, the stations may not be stored in order, and the station names may not be stored correctly.
 - For information on scrambled broadcasts, refer to "When Receiving A Scrambled Broadcast (DVD Deck Only)" (☞ pg. 87).

IMPORTANT:

- In certain reception conditions, station names may not be stored correctly, and Auto Guide Program Number Set may not work properly. When the Guide Program numbers are not set properly, the programme that you do not intended to record will be timer-recorded by the SHOWVIEW system of the unit. When programming the timer using the SHOWVIEW system, be sure to check the desired channel is selected correctly. (☞ pg. 29)
- Your unit memorises all receivable stations even if reception of some of them is poor. You can delete those stations with an unacceptable picture from the list. (☞ pg. 86, "Delete A Channel")

NOTES:

- Fine tuning is performed automatically during Auto Channel Set. If you want to perform tuning manually, refer to "Fine-Tuning Channels Already Stored" (☞ pg. 87).
- If you perform Auto Channel Set when the aerial cable is not connected properly, "SCAN COMPLETED –NO SIGNAL–" appears on the TV screen in step 7. In such a case, make sure of the aerial connection and press **ENTER**; Auto Channel Set will start again.
- If no sound accompanies the picture or the audio sounds unnatural on some channels that have been stored by Auto Set Up, the TV system setting for those channels may be incorrect. Select the appropriate TV system for those channels. (☞ pg. 87, "INFORMATION")

Manual Channel Set

Store channels that were not stored during Auto Set Up (pg. 17), Preset Download (pg. 18) or Auto Channel Set (pg. 84).

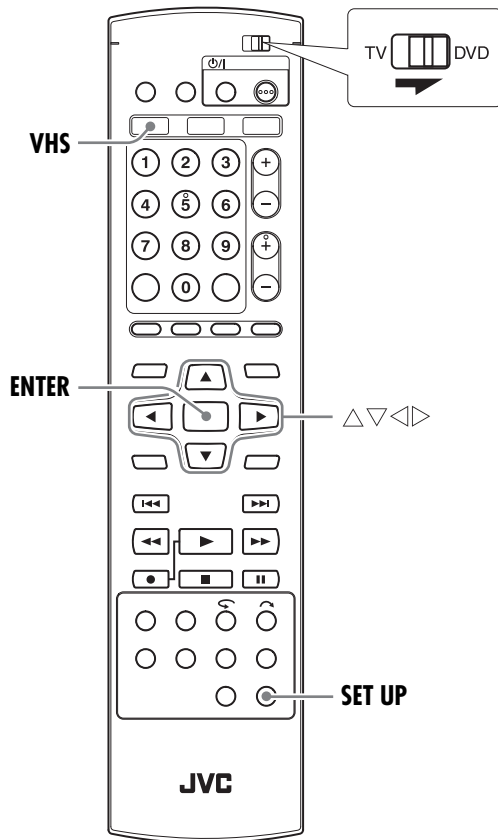

- 1 Press **SET UP** to access the Main Menu screen.
- 2 Press $\triangleleft \triangleright$ to select "INITIAL SET UP", then press ∇ .
- 3 Press $\triangleleft \triangleright$ to select "MANUAL CH SET", then press ∇ . The Confirmation screen appears.
- 4 Press $\triangle \nabla \triangleleft \triangleright$ to select a blank position in which you want to store a channel, then press **ENTER** twice. The Manual Channel Set screen appears.
- 5 Press $\triangle \nabla$ to select "BAND", then press **ENTER**.

(Example) To store in position 12.

DVD SET UP			FUNCTION SET UP			INITIAL SET UP		
INITIAL SET UP / MANUAL CH SET								
PR	CH	ID	PR	CH	ID			
01	25	ARD	08	C26	E-SP			
02	C06	SKY1	09	55	WEST			
03	09	ZDF	10	C24	SAT			
04	093	DA11	11	C23	DSF			
05	031	BBC1	12					
06	C32	BBC2	13					
07	033	3SAT	14					

The programme currently received on the selected channel position appears behind the confirmation screen.

- 6 Press $\triangle \nabla$ to change the band between CH (regular) and CC (cable), then press **ENTER**.
- 7 Press $\triangle \nabla$ to select "CH", then press **ENTER**.
- 8 Press $\triangle \nabla$ to input the channel number you want to store.

DVD SET UP			FUNCTION SET UP			INITIAL SET UP		
INITIAL SET UP / MANUAL CH SET								
BAND			CH					
CH			CC					
ID								
DECODER			OFF					
FINE								

- To enter the registered station name (pg. 97), press $\triangle \nabla$ to select "ID", then press **ENTER**. Press $\triangle \nabla$.
 - For fine tuning adjustment, press $\triangle \nabla$ to select "FINE", then press **ENTER**. Press $\triangle \nabla$ to perform fine-tuning.
 - When storing a channel that sends scrambled broadcasts, press $\triangle \nabla$ to select "DECODER", then press **ENTER**. Press $\triangle \nabla$ to set "DECODER" to "ON" ("OFF" is the default setting).
 - When "L-2 SELECT" is set to "VIDEO/RGB", "S-VIDEO/RGB" or "SAT VIDEO/RGB", the "DECODER" setting cannot be changed. (pg. 45)
- 9 Press **ENTER** to enter new channel information. The Confirmation screen appears.
 - Repeat steps 4 – 9 as necessary.
 - 10 Press **SET UP** to close the Confirmation screen.
 - When Auto Channel Set is completed, "PLEASE WAIT" will be displayed for about 90 seconds, since channel data is exchanged between the DVD deck and the VHS deck. No operations will be done during this time.
 - To change positions, see "Change Station Channel Position" (pg. 86).
 - If you wish to set station names other than the ones registered in your unit, see "Set Stations (B)" (pg. 87).

ATTENTION:

Guide Program numbers are not set when channels are stored manually. (pg. 83, "SHOWVIEW™ System Setup")

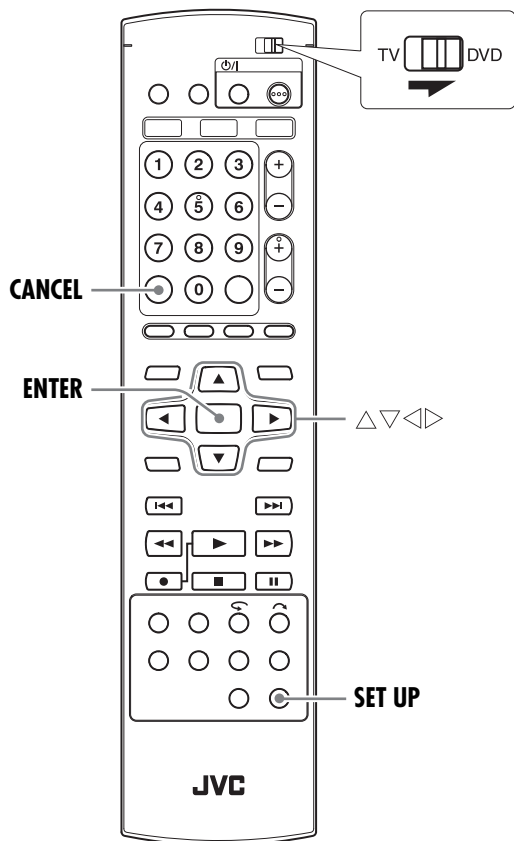

Delete A Channel

- 1** Perform steps 1 – 3 of “Manual Channel Set” (pg. 85) to access the Confirmation screen.
- 2** Press $\Delta \nabla \triangleleft \triangleright$ to select the item you want to delete.
- 3** Press **CANCEL** to delete a channel. The item next to the cancelled one moves up one line.
 - Repeat steps 2 and 3 as necessary.
- 4** Press **SET UP** to close the Confirmation screen.

Change Station Channel Position

- 1** Perform steps 1 – 3 of “Manual Channel Set” (pg. 85) to access the Confirmation screen.
- 2** Press $\Delta \nabla \triangleleft \triangleright$ to select the item you want to move, then press **ENTER**.
- 3** Press $\Delta \nabla \triangleleft \triangleright$ to select the new channel position, then press **ENTER**.

Example: If you moved the station in position 4 to position 2, the stations originally in positions 2 and 3 each move down one space.

DVD SET UP			FUNCTION SET UP			INITIAL SET UP		
PR	CH	ID	PR	CH	ID	PR	CH	ID
01	25	ARD	08	C26	E-SP			
02	C08	SKY1	09	58	WEST			
03	10	ZDF	10	C24	SAT1			
04	C65	DAI1	11	C23	OSF			
05	C31	BBC1	12		----			
06	C32	BBC2	13		----			
07	C33	SSAT	14		----			



DVD SET UP			FUNCTION SET UP			INITIAL SET UP		
PR	CH	ID	PR	CH	ID	PR	CH	ID
01	25	ARD	08	C26	E-SP			
02	C65	DAI1	09	58	WEST			
03	C08	SKY1	10	C24	SAT1			
04	10	ZDF	11	C23	OSF			
05	C31	BBC1	12		----			
06	C32	BBC2	13		----			
07	C33	SSAT	14		----			

- Repeat steps 2 and 3 as necessary.

- 4** Press **SET UP** twice to close the Confirmation screen.

When Receiving A Scrambled Broadcast (DVD Deck Only)

- 1** Set "L-2 SELECT" to "DECODER". (ⓘ pg. 45)
- 2** Perform steps 1 – 3 of "Manual Channel Set" (ⓘ pg. 85).
- 3** Press $\triangle \nabla \triangleleft \triangleright$ to select the channel position broadcasting scrambled programmes, then press **ENTER** twice.
- 4** Press $\triangle \nabla$ to select "DECODER", then press **ENTER**.
- 5** Press $\triangle \nabla$ to set "DECODER" to "ON", then press **ENTER**.
- 6** Press **RETURN** to return to the Confirmation screen.
 - Repeat steps 3 – 6 as necessary.
- 7** Press **SET UP** twice to close the Confirmation screen.

INFORMATION

If you live in Eastern Europe, "TV SYSTEM" setting appears instead of "DECODER" setting on the Manual Channel Set screen. When you can see the picture but can hear no audio, select appropriate TV system (D/K or B/G). Normally, TV programmes are broadcast as follows.

For Eastern Europe: D/K

For Western Europe: B/G

- 1** Select a country in Eastern Europe in step 4 of "Auto Channel Set" (ⓘ pg. 84).
- 2** Press $\triangle \nabla$ to select "TV SYSTEM" in step 5 of "Manual Channel Set" (ⓘ pg. 85).
- 3** Press $\triangle \nabla$ to select appropriate TV System (D/K or B/G).

Set Stations (A)

Set station names that are registered in your unit.

- 1** Perform steps 1 – 3 of "Manual Channel Set" (ⓘ pg. 85) to access the Confirmation screen before continuing.
- 2** Press $\triangle \nabla \triangleleft \triangleright$ to select the item you want.
- 3** Press **ENTER** twice to access the Manual Channel Set screen.
- 4** Press $\triangle \nabla$ to select "ID", then press **ENTER**.
- 5** Press $\triangle \nabla$ until the new station's name (ID) you want to store appears, then press **ENTER**. Registered station names (ⓘ pg. 97) appear as you press $\triangle \nabla$.
- 6** Press $\triangleleft \triangleright$ to select "OK", then press **ENTER**.
 - Repeat steps 2 – 6 as necessary.
- 7** Press **SET UP** twice to close the Confirmation screen.

Set Stations (B)

Set station names other than the ones registered in your unit.

- 1** Perform steps 1 – 3 of "Manual Channel Set" (ⓘ pg. 85) to access the Confirmation screen and then perform steps 2 and 3 of "Set Stations (A)" above before continuing.
- 2** Press $\triangle \nabla$ to select "ID", then press **ENTER**.
- 3** Press **ENTER** twice.
- 4** Press $\triangleleft \triangleright$ to locate the character insertion point.
- 5** Press $\triangle \nabla$ to cycle through the characters (A–Z, 0–9, –, *, +, _ (space)) and stop when the desired character is indicated, then press \triangleright to enter.
 - Enter the remaining characters the same way (maximum of 4).
- 6** After entering all characters, press $\triangleleft \triangleright$ to select "OK", then press **ENTER**.
- 7** Press **SET UP** twice to close the Confirmation screen.

NOTE:

The characters available for the station name (ID) are A–Z, 0–9, –, *, +, _ (space) (maximum of 4).

Fine-Tuning Channels Already Stored

- 1** Perform steps 1 – 3 of "Manual Channel Set" (ⓘ pg. 85) to access the Confirmation screen before continuing.
- 2** Press $\triangle \nabla \triangleleft \triangleright$ to select the channel you want to fine-tune, then press **ENTER**.
- 3** Press **ENTER** twice.
- 4** Press **ENTER** to access the Manual Channel Set screen. The Manual Channel Set screen appears.
- 5** Press $\triangle \nabla$ to select "FINE".
- 6** Press $\triangleleft \triangleright$ until the picture appears in its best quality.
 - Repeat steps 2 – 6 as necessary.
- 7** Press **SET UP** three times to close the Confirmation screen.

Clock Set

IMPORTANT:

If you performed Auto Set Up (pg. 17) or Preset Download (pg. 18), without ever having set the clock previously, the unit's built-in clock is also set automatically.

Perform the following steps only if —

— Auto Clock Set has not been performed correctly by Auto Set Up or Preset Download.

OR

— you want to change Just Clock setting. (pg. "Just Clock" in the right column)

- Turn on the unit.
- Turn on the TV and select the AV mode.
- Slide the TV/DVD switch to DVD.

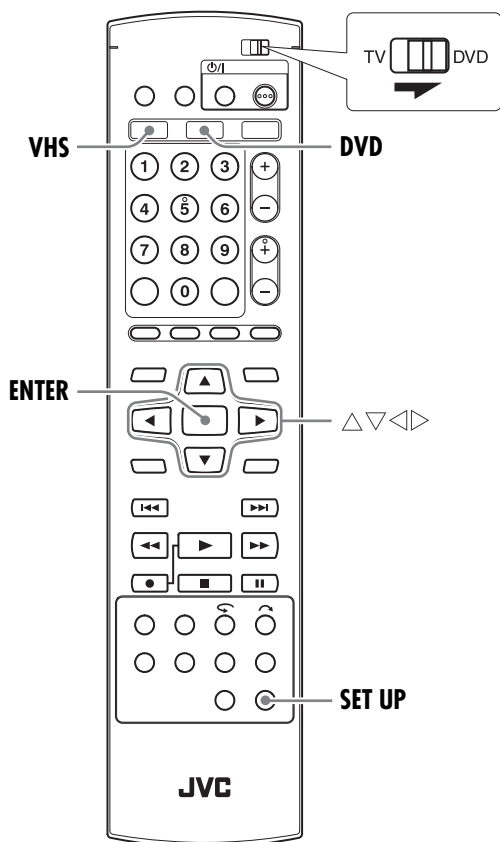

1 Press $\triangleleft \triangleright$ to select "INITIAL SET UP", then press ∇ .

2 Press $\triangleleft \triangleright$ to select "CLOCK SET", then press ∇ .

NOTE:

When you have selected MAGYARORSZÁG, ČESKÁ REPUBLIKA, POLSKA or OTHER EASTERN EUROPE for the country setting (pg. 19), you cannot use Just Clock function. Skip steps 4 and 5.

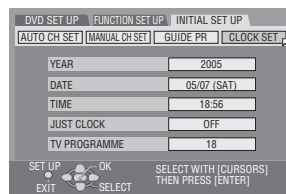

3 Press $\triangle \nabla$ to select "YEAR", then press **ENTER**. Press $\triangle \nabla$ to set the year, then press **ENTER**.

- Repeat the same procedure to set the date and time. When you set the time, press and hold $\triangle \nabla$ to change the time by 30 minutes.
- When you set the date, press and hold $\triangle \nabla$ to change the date by 15 days.

4 Press $\triangle \nabla$ to select "JUST CLOCK", then press **ENTER**. Press $\triangle \nabla$ to set to the desired mode, then press **ENTER**.

- The default setting is "OFF".
- For the Just clock function, refer to "Just Clock" below.
- If you set to "OFF", you can disregard the next step as you won't be able to receive regular clock adjustments.

5 Press $\triangle \nabla$ to select "TV PROGRAMME", then press **ENTER**. Press $\triangle \nabla$ to set the channel position to the number representing the station transmitting clock setting data, then press **ENTER**.

- The unit is preset to receive clock setting and adjustment data from channel position 1.

6 Press **SET UP** to start the clock operation.

NOTES:

- Just Clock (when set to "ON") adjusts the unit's built-in clock every hour, except for 23:00, 0:00, 1:00 and 2:00.
- Just Clock is not effective when:
 - the unit's power is on.
 - the unit is in the Timer mode.
 - a difference of more than 3 minutes exists between the built-in clock's time and the actual time.
 - the unit is in the Automatic Satellite Programme Recording mode. (pg. 36) (DVD deck only)
 - the unit is in the Power Save mode. (pg. 79)
 - "L-2 SELECT" is set to "SAT VIDEO/RGB". (pg. 45)
- If Just Clock is set to "ON", the unit's clock is automatically adjusted at the start/end of Summer Time.
- Just Clock may not function properly depending on the reception condition.

Just Clock

The Just Clock function provides accurate time keeping through automatic adjustments at regular intervals, by reading data from a PDC signal.

The Just Clock option can be set to "ON" or "OFF" at the Clock Set screen (the default setting is "OFF").

IMPORTANT:

If you turn off Just Clock, the accuracy of your unit's built-in clock may be reduced, which could adversely effect timer recording. We recommend you to keep Just Clock on. In cases where the clock setting data from a PDC signal is incorrect, however, you are advised to keep Just Clock set to "OFF".

Format A Disc (DVD Deck Only)

DVD
RAMDVD
RW

Some DVD-RAM/RW discs are unformatted. Format the disc when you use an unformatted disc or you want to delete all recordings and data on the disc.

ATTENTION:

- When a disc is formatted, all recordings and data are erased. It is impossible to restore them.
- Never turn off the unit or disconnect the AC power cord while "NOW FORMATTING..." is displayed on the TV screen.

- Turn on the unit.

- Turn on the TV and select the AV mode.
- Slide the **TV/DVD** switch to **DVD**.
- Load a DVD-RAM/RW disc to format.

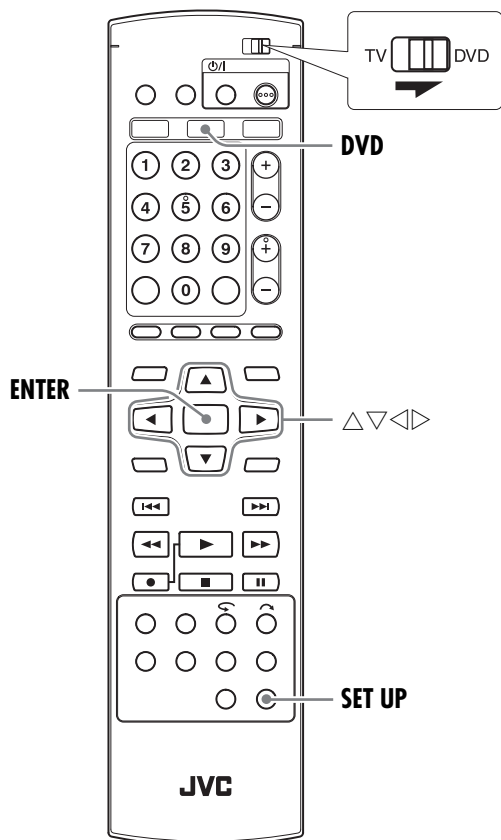

Format A DVD-RAM Disc

- 1 Press **DVD** so that the DVD lamp lights up on the unit.
- 2 Press **SET UP** to access the Main Menu screen.
- 3 Press $\triangleleft \triangleright$ to select "DVD SET UP", then press ∇ .
- 4 Press $\triangleleft \triangleright$ to select "UTILITY", then press ∇ .
- 5 Press $\triangle \nabla \triangleleft \triangleright$ to select "FORMAT", then press **ENTER**. Press $\triangleleft \triangleright$ to select "YES", then press **ENTER**.
- 6 Press $\triangleleft \triangleright$ to select "OK", then press **ENTER**.

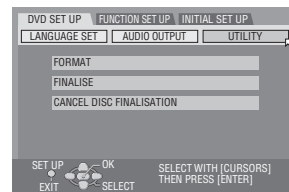

Format A DVD-RW Disc

- 1 Perform steps 1 to 4 of "Format A DVD-RAM Disc" as above before continuing.
- 2 Press $\triangle \nabla \triangleleft \triangleright$ to select "FORMAT", then press **ENTER**. Press $\triangleleft \triangleright$ to choose "VR MODE" or "VIDEO MODE", then press **ENTER** when "DISC WILL BE FORMATTED" appears on the TV screen. "VR MODE": To be chosen when you want to record, erase, or edit data on the disc repeatedly. "VIDEO MODE": To be chosen when you want to erase all the data on the disc once played back to record new data, or play back the disc on other DVD players.
- 3 Press $\triangleleft \triangleright$ to select "YES", then press **ENTER**.

NOTES:

- It is impossible to format Version 1.0 DVD-RW discs in Video mode.
- It is impossible to format DVD-R discs.
- All the titles on a disc will be deleted once the disc is formatted even if they are protected titles. (pg. 67)

Finalise A Disc (DVD Deck Only)

DVD
RDVD
RW

Finalising DVD-R/RW discs recorded on this unit makes it possible for the discs to be played back on other DVD players. DVD-RW discs are finalised in the mode that the discs were formatted, enabling playback on compatible DVD players.

Title names input in the Library Database DVD Navi are registered as title names in the DVD menu. (☞ pg. 67)

- Turn on the unit.
- Turn on the TV and select the AV mode.
- Slide the **TV/DVD** switch to **DVD**.
- Load a DVD-R/RW disc to finalise.

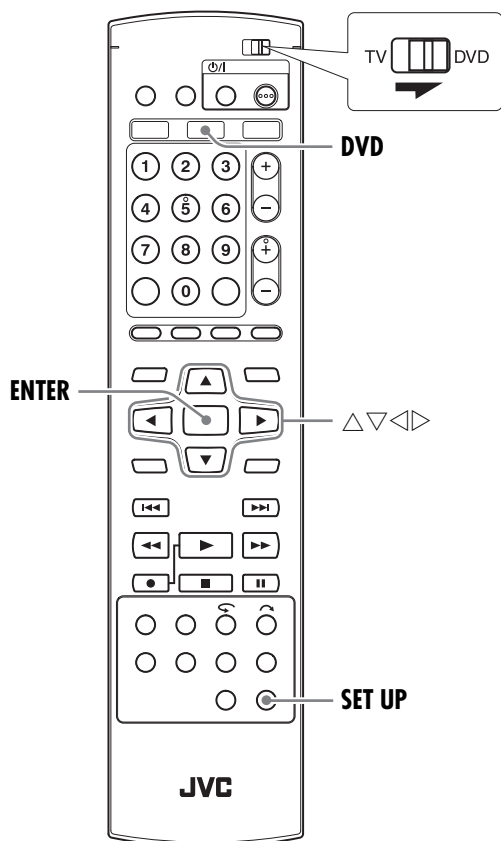

Before finalising

- It is possible to record on a blank space.
- It is possible to enter title names. (☞ pg. 67)
- It is possible to delete titles. (☞ pg. 67)
- It is impossible to overwrite recorded areas of DVD-R discs.
- Available recording capacity does not increase even if a recorded title is deleted from a DVD-R disc.
- It is impossible to record or edit DVD-R/RW discs recorded on other devices even if they have not been finalised.

After finalising (For DVD-R/RW (Video mode) discs)

- Video and audio that have been recorded by then are recorded in conformity to the DVD Video standard, enabling you to play back the discs as DVD VIDEO discs.
- Although DVD-R/RW discs finalised on this unit become playable on DVD players compatible with DVD-R/RW discs, some discs still may not play, for which JVC cannot take responsibility.
- Marked points marked before finalising will be deleted, and titles will be divided automatically into "chapters" approximately every 5 minutes. (☞ pg. 49)
- Depending on the DVD players and DVD-R/RW discs used, and on the conditions of recording, it may not be possible to play back the discs. In this case, play back the discs on this unit.
- Additional recordings become impossible.

Finalise A DVD-R/RW Disc

1 Perform steps **1** to **4** of "Format A DVD-RAM Disc" (☞ pg. 89) before continuing.

2 Press $\Delta \nabla \triangleleft \triangleright$ to select "FINALISE", then press **ENTER**.

• For DVD-R/RW (Video mode) discs, the background selection screen will appear. Press $\Delta \nabla \triangleleft \triangleright$ to select the desired background from a selection of 18 backgrounds.

3 Press $\triangleleft \triangleright$ to select "OK", then press **ENTER**.

4 Press $\triangleleft \triangleright$ to select "OK", then press **ENTER**.

5 Press **SET UP** to return to the normal screen.

• Menu screen is cleared.

• Once a DVD-R/RW (Video mode) disc has been finalised, the displays for original and play list do not appear. Only display for library appears.

• Once a DVD-RW (VR mode) disc has been finalised, it can be played on DVD players compatible with VR mode.

Cancel The Finalisation Of A DVD-RW Disc

1 Load a DVD-RW disc to cancel the disc finalisation, and perform steps **1** to **4** of "Format A DVD-RAM Disc" (☞ pg. 89) before continuing.

2 Press $\Delta \nabla \triangleleft \triangleright$ to select "CANCEL FINALISATION", then press **ENTER**.

3 Press $\triangleleft \triangleright$ to select "EXECUTE", then press **ENTER**.

4 Press **SET UP** to return to the normal screen.

• When the disc finalisation is cancelled, the mode in which the disc was formatted is restored, making the disc recordable. (☞ pg. 7, 89)

Before requesting service for a problem, use this chart and see if you can solve the trouble yourself. Small problems are often easily solved, and this can save you the trouble of sending your unit off for repair.

Initialising (DVD Deck Only)

Malfunction occurs on the unit.

→ Press $\odot/|$ to turn off the unit, press and hold $\odot/|$, then press \blacksquare for two seconds or more.

General

No power is supplied to the unit.

- The AC power plug is disconnected from the AC outlet.

→ Connect the AC power plug to the AC outlet securely. (☞ pg. 15)

The disc tray cannot be opened.

→ Open the disc tray by following the steps below.

1. Press \blacksquare and $\odot/|$ on the unit simultaneously.
2. Press and hold \blacktriangle (OPEN/CLOSE) on the unit for approximately 30 seconds until the tray is opened.
3. Remove the disc, then press \blacktriangle (OPEN/CLOSE). The unit shuts off.

The remote control does not work properly.

→ Remove the batteries, wait for 5 minutes or more, then load the batteries again.

- The setting of the remote control code is inappropriate.

→ Set the same remote control code (1, 2, 3, or 4) on both the unit and the remote control. (☞ pg. 74)

- The batteries are discharged.

→ Replace the dead batteries with new ones.

Dubbing from the external equipment is not possible.

- The source (another video recorder, camcorder) has not been properly connected.

→ Confirm that the source is properly connected.

- All necessary power switches have not been turned on.

→ Confirm that all units' power switches are turned on.

- The setting of the input channel position is inappropriate.

→ Select the input channel position ("F-1", "L-1" or "L-2") that corresponds to the input terminal connected to the external equipment. (☞ pg. 43)

The on-screen display superimposed on the programme played back/received on this unit is recorded when you dub the programme to an external recording equipment.

→ Set "SUPERIMPOSE" to "OFF". (☞ pg. 79)

The unit does not operate.

- There are cases when the operation is prohibited on the disc.

- Lightning or static electricity may cause malfunction of the unit.

→ Press $\odot/|$ to turn the power off, then press the button again to turn the power on.

The remote control of a JVC TV will not operate the unit.

- The setting of the remote control code is inappropriate.

→ To operate the unit using a JVC TV remote control, set the remote control code of the unit to "1" (Default: "3"). (☞ pg. 74)

Playback (DVD Deck)

The DVD deck cannot be operated.

- The DVD deck is not selected.

→ Press **VHS/DVD** on the unit repeatedly or **DVD** on the remote control so that the DVD lamp lights up on the unit.

Images do not appear on the TV screen.

- The TV receiver's channel selector is not set to the AV mode.

→ Set the TV to its AV mode.

- When interlace scanned programme is played back, progressive scan mode is selected.

→ Press and hold **PROGRESSIVE SCAN** until **P** disappears from the front display panel. (☞ pg. 80)

Playback does not start or stop immediately after playback is started by pressing \blacktriangleright . On the front display panel, "NO DISC" appears.

- The disc is loaded upside down.

→ Place the disc on the disc tray with the playback surface facing down. (☞ pg. 9)

- A disc not being compatible with the unit is loaded.

→ Load a playable disc on the unit. (☞ pg. 6)

- A dirty disc is loaded.

→ Clean the disc. (☞ pg. 9)

- Defective disc is loaded.

→ Replace the warped or scratched disc with a normal one.

Images are blurred or distorted when you start High-Speed Search.

→ Images are blurred or distorted at the point where the playback speed changes and this is not a malfunction of the unit.

Playback does not start.

→ Playback does not start for approximately 30 seconds after recording is stopped and this is not a malfunction of the unit.

Playback (VHS Deck)

The VHS deck cannot be operated.

- The VHS deck is not selected.
- Press **VHS/DVD** on the unit repeatedly or **VHS** on the remote control so that the VHS lamp lights up on the unit.

The tape will not rewind or fast-forward.

- The tape is already fully rewound or fast-forwarded.
- Check the cassette.

The playback picture does not appear while the tape is running.

- The TV receiver's channel selector is not set to the AV mode.
- Set the TV to its AV mode.

Noise appears during visual search.

- This is normal.

Noise appears during normal playback.

- The automatic tracking mode is engaged.
- Try manual tracking. (☞ pg. 60)

The playback picture is blurred or interrupted while TV broadcasts are clear or "USE CLEANING CASSETTE" message appears on the screen.

- The video heads may be dirty.
- Use a dry cleaning cassette, or consult your JVC dealer.

Breaks are noticeable in Hi-Fi soundtrack.

- The automatic tracking mode is engaged.
- Try manual tracking. (☞ pg. 60)

Recording (DVD Deck)

The desired programme cannot be recorded.

- The channel position does not correspond to that in the receiving area.
- Set the correct channel position for the receiving broadcast. (☞ pg. 85)

Recording cannot be made.

- No disc or a disc not being compatible with the unit is loaded.
- Load a recordable disc on the unit. (☞ pg. 6)
- The disc loaded is not formatted.
- Format the disc. (☞ pg. 89)
- A finalised DVD-R disc is loaded.
- Recording cannot be made on finalised discs. Load a recordable disc on the unit.
- The disc is full or does not have enough space for the title to be recorded.
- Clear unnecessary titles on the disc or load a blank disc. (☞ pg. 67)

Recording (VHS Deck)

During recording, the tape does not run. The VHS recording lamp lights up on the unit.

- The unit is in the Record Pause mode.
- Press **▶** to resume recording.

Recording cannot be done.

- There is no cassette loaded, or the cassette loaded has had its record safety tab removed.
- Insert a cassette, or using adhesive tape, cover the hole where the tab was removed.

TV broadcasts cannot be recorded.

- "L-1", "L-2" or "F-1" has been selected as the input mode.
- Set to the desired channel.

Camcorder recording is not possible.



- The camcorder has not been properly connected.
- Confirm that the camcorder is properly connected.
- The input mode is not correct.
- Set the input mode to "F-1".

The tape is automatically stopped, and "⏏" on the front display panel won't stop blinking.

- The end of the tape was reached during recording.
- The programme may not have been recorded in its entirety. Next time make sure you have enough time on the tape to record the entire programme.

Timer Recording (DVD Deck)

"NO DISC" appears on the front display panel.

- No disc is loaded.
- Press **TIMER**  so that the DVD timer lamp lights off. Load a recordable disc, then press **TIMER**  again.

Timer programming cannot be made.

- Date and time is not correct.
- Set date and time correctly. (☞ pg. 88)
- Timer recording is in progress.
- Timer programming can't be performed while a timer recording is in progress. Wait until it finishes.

Timer programming recording does not start.

- Date and time is not correct.
- Set date and time correctly. (☞ pg. 88)

SHOWVIEW Timer Programming cannot be made.

- Date and time set on the unit is not correct.
- Set date and time correctly. (☞ pg. 88)
- The channel position does not correspond to that in the receiving area.
- Set the correct channel position for the receiving broadcast. (☞ pg. 85)

The SHOWVIEW system does not timer-record properly.

- The unit's channel positions have been set incorrectly.
- Refer to "SHOWVIEW™ System Setup" (☞ pg. 83) and reperform the procedure.

Automatic Satellite Programme Recording does not start.

- The satellite receiver is not connected properly to this unit.
- Connect the satellite receiver to the [L-2 IN/DECODER] connector properly. (☞ pg. 76)

On the front display panel, “-:-” appears.

- Power failure occurred.
- Set date and time correctly. (☞ pg. 88)



“PROGRAMME FULL” appears on the TV screen during timer programming.

- 8 programmes have already been timer programmed.
- Clear unnecessary programmes on the unit, then try timer programming again. (☞ pg. 34)

The disc space does not increase when recorded titles are cleared.

- The PC's data recorded on a DVD-RAM drive cannot be cleared on this unit.
- Format the disc. (When the disc is soiled, wipe the disc with a soft dry cloth before formatting.) (☞ pg. 9, 89)

Timer Recording (VHS Deck)**“NO TAPE” appears on the front display panel.**

- No tape is loaded.
- Press **TIMER**  so that the VHS timer indicator lights off. Load a cassette with the record safety tab intact, then press **TIMER**  again.

Timer programming cannot be made.

- Date and time is not correct.
- Set date and time correctly. (☞ pg. 88)
- The timer is not engaged.
- Press **TIMER**  and confirm that the VHS timer indicator lights up on the front panel display.
- Timer recording is in progress.
- Timer programming can't be performed while a timer recording is in progress. Wait until it finishes.

Timer programming recording does not start.

- Date and time is not correct.
- Set date and time correctly. (☞ pg. 88)
- The timer is not engaged.
- Press **TIMER**  and confirm that the VHS timer indicator lights up on the front panel display.

The VHS timer indicator on the front display panel won't stop blinking.

- The timer is engaged but there's no cassette loaded.
- Load a cassette with the record safety tab intact.
- The loaded cassette has had its record safety tab removed.
- Remove the cassette and cover the hole with adhesive tape, or insert a cassette with the record safety tab intact.

The tape is automatically stopped, and “” and the VHS timer indicator on the front display panel won't stop blinking.

- The end of the tape was reached during timer recording.
- The programme may not have been recorded in its entirety. Next time make sure you have enough time on the tape to record the entire programme.
- The end of the tape was reached during Instant Timer Recording.
- The programme may not have been recorded in its entirety. Next time make sure you have enough time on the tape to record the entire programme.

SHOWVIEW Timer Programming cannot be made.

- Date and time set on the unit is not correct.
- Set date and time correctly. (☞ pg. 88)
- The channel position does not correspond to that in the receiving area.
- Set the correct channel position for the receiving broadcast. (☞ pg. 85)

The SHOWVIEW system does not timer-record properly.

- The unit's channel positions have been set incorrectly.
- Refer to “SHOWVIEW” System Setup” (☞ pg. 83) and reperform the procedure.

Other Problems**The image of the TV broadcast appears distorted on the TV screen.****For composite connection**

- Press **PROGRESSIVE SCAN** for 3 or more seconds so that the Video output indicator (**P**) lights off on the front display panel.

For component video connection

- Press **PROGRESSIVE SCAN** for 3 or more seconds so that the Video output indicator (**P**) lights up on the front display panel.

When scanning channels, some of them are skipped over.

- Those channels have been designated to be skipped.
- If you need the skipped channels, restore them. (☞ pg. 85)

The channel cannot be changed.

- Recording is in progress.
- Press **II** to pause the recording, change channels, then press **▶** to resume recording.

Channel settings that were made manually seem to have changed or disappeared.

- After the manual settings were made, Auto Channel Set was performed.
- Perform “Manual Channel Set” (☞ pg. 85).

Malfunction occurs and the unit cannot be power off.

- Reset the unit by disconnecting the AC power plug from the AC outlet and connect again.

On-screen Message

DISC NOT REGISTERED IN THE LIBRARY REGISTER DISC?

- A disc that is not registered in the library has been inserted. Register the disc as necessary. (☞ pg. 71)

INSERT DISC #XXXX

- Appears when a title that has been selected in the library is not contained in the loaded disc.

CAN NOT RECORD OR MAKE PLAY LIST DELETE UNWANTED TITLES

- Recording and/or editing cannot be performed.
- The number of titles exceeds 99.
- The number of play lists exceeds 999.

SET CLOCK BEFORE TIMER PROGRAMMING

- To set the timer programme, the clock must be set in advance. (☞ pg. 88)

PROGRAMME FULL DELETE UNWANTED TIMER PROGRAMME

- You can programme each deck to timer-record as many as 8 programmes. To programme more, you need to cancel a timer programme already set. (☞ pg. 34)

NO DISC INSERTED

- Operation has been attempted when a disc is not loaded, or loaded upside down. (☞ pg. 9)

DISC NOT RECORDABLE INSERT RECORDABLE DISC

- When a playback-only disc or a finalised disc is loaded, ● has been pressed. (☞ pg. 6)

SHOWVIEW NO. ERROR CONFIRM SHOWVIEW NO. THEN RETRY

- An invalid SHOWVIEW number has been input. (☞ pg. 29)

GUIDE PROGRAMME IS NOT SET SELECT CHANNEL YOU WANT TO RECORD

- To set the timer programme using the SHOWVIEW system, the Guide Program Number must be set in advance. (☞ pg. 83)

CAN NOT SET SHOWVIEW TIMER PROGRAMMING DURING TIMER RECORDING OR INSTANT TIMER RECORDING CANCEL TIMER RECORDING OR INSTANT TIMER RECORDING THEN ENTER THE SHOWVIEW CODE AGAIN

- Appears when you tried to input a SHOWVIEW number during timer recording or instant timer recording.

REGION CODE ERROR CHECK DISC

- A disc loaded cannot be played back on this unit since the region number of the disc does not match that of the unit. (☞ pg. 7)

UNREADABLE DISC CHECK DISC

- When an incompatible disc is loaded, ► has been pressed. (☞ pg. 7)

COULD NOT FORMAT THE DISC CHECK THE DISC

- Formatting is not complete since the disc may be dirty or damaged. Take out the disc, clean it and retry. (☞ pg. 9, 89)

COULD NOT FINALISE THIS DISC CHECK THE DISC

- Finalising is not complete since the disc may be dirty or damaged. Take out the disc, clean it and retry. (☞ pg. 9, 90)

COULD NOT CANCEL DISC FINALISATION CHECK THE DISC

- Canceling disc finalisation is not complete since the disc may be dirty or damaged. Take out the disc, clean it and retry. (☞ pg. 9, 90)

PRESS [STOP] AGAIN TO STOP RECORDING

- During Live Memory playback, ■ has been pressed. (☞ pg. 54)

TIMER RECORDING COMPLETED

- Timer recording has finished during Live Memory playback.

PLAYBACK WILL STOP THEN TIMER RECORDING WILL START

- Timer recording finished during Live Memory playback, then the next timer recording is about to begin while playback continues.

COPY PROHIBITED CAN NOT RECORD

- An attempt has been made to record copy-protected contents.
- An attempt has been made to record copy-once contents on a disc that is not CPRM compatible, such as DVD-R.

COPY PROHIBITED CAN NOT PLAY

- The unit has detected invalid contents at the start or in the middle of playback.

THE i.LINK DEVICE THAT YOU HAVE CONNECTED IS NOT RECOGNIZED MAKE SURE THAT THE DEVICE IS CONNECTED PROPERLY AND POWERED ON

- An attempt has been made to start DV dubbing when a digital video camera is not properly connected to the unit.
- Check the connection. (☞ pg. 41)

GENERAL**Power requirement**

AC 220 V – 240 V~, 50/60 Hz

Power consumption

Power on: 38 W

Power off: 7.0 W

Temperature

Operating: 5°C to 35°C

Storage: –20°C to 60°C

Operating position

Horizontal only

Dimensions (WxHxD)

435 mm x 96 mm x 344 mm

Weight

5.8 kg

Input/Output

Video input: 1.0 Vp-p, 75 Ω (pin jack)

Audio input:

–8 dB, 50 kΩ (pin jack)

Corresponding to mono (left)

Audio output: –8 dB, 1 kΩ (pin jack)

21-pin SCART connectors:

IN/OUT x 1, IN/DECODER x 1

Input/Output (DVD Deck Only)

S-video input:

Y: 1.0 Vp-p, 75 Ω

C: 0.300 Vp-p, 75 Ω

i.Link: 4-pin for DV input

Component video output:

Y: 1.0 Vp-p, 75 Ω

Cb/Cr, Pb/Pr: 0.7 Vp-p, 75 Ω

Corresponding to copy protection

Digital audio output: Coaxial

Corresponding to Dolby Digital and DTS Digital Surround

Bit stream

Selectable in digital audio output setting menu

VIDEO/AUDIO (DVD Deck)**Recording time**

Maximum 8 hours (with 4.7 GB disc)

(XP): Approx. 1 hour

(SP): Approx. 2 hours

(LP): Approx. 4 hours

(EP): Approx. 6 hours

(FR): Approx. 1 hour – 8 hours

Audio recording system

Dolby Digital (2 ch)

Linear PCM (XP mode only)

Video recording compression system

MPEG2 (CBR/VBR)

VIDEO/AUDIO (VHS Deck)**Signal system**

PAL colour signal and CCIR monochrome signal, 625 lines/50 fields

Recording system

DA4 (Double Azimuth) head helical scan system

Format

VHS PAL standard

Maximum recording time

(SP): 180 min. with E-180 video cassette

(LP): 360 min. with E-180 video cassette

Signal-to-noise ratio

45 dB

Horizontal resolution

230 lines

Frequency range

(Normal audio): 70 Hz to 10,000 Hz

(Hi-Fi audio): 20 Hz to 20,000 Hz

Specifications shown are for SP mode unless otherwise specified.

TUNER/TIMER**TV channel storage capacity**

99 positions (+AUX position)

Tuning system

Frequency synthesizer tuner

Channel coverage

VHF 47 MHz – 89 MHz/

104 MHz – 300 MHz/

302 MHz – 470 MHz

UHF 470 MHz – 862 MHz

Memory backup time

Approx. 10 minutes

ACCESSORIES**Provided accessories**

RF cable,

21-pin SCART cable,

Infrared remote control unit,

“R6” battery x 2

E.& O.E. Design and specifications subject to change without notice.

ATTENTION:

This unit contains microcomputers. External electronic noise or interference could cause malfunctioning. In such cases, switch the unit off and unplug the AC power cord. Then plug it in again and turn the unit on. Take out the disc. After checking the disc, operate the unit as usual.

Language Code List

AA	Afar	IK	Inupiak	RN	Kirundi
AB	Abkhazian	IN	Indonesian	RO	Rumanian
AF	Afrikaans	IS	Icelandic	RU	Russian
AM	Ameharic	IW	Hebrew	RW	Kinyarwanda
AR	Arabic	JI	Yiddish	SA	Sanskrit
AS	Assamese	JW	Javanese	SD	Sindhi
AY	Aymara	KA	Georgian	SG	Sangho
AZ	Azerbaijani	KK	Kazakh	SH	Serbo-Croatian
BA	Bashkir	KL	Greenlandic	SI	Singhalese
BE	Byelorussian	KM	Cambodian	SK	Slovak
BG	Bulgarian	KN	Kannada	SL	Slovenian
BH	Bihari	KO	Korean (KOR)	SM	Samoaan
BI	Bislama	KS	Kashmiri	SN	Shona
BN	Bengali, Bangla	KU	Kurdish	SO	Somali
BO	Tibetan	KY	Kirghiz	SQ	Albanian
BR	Breton	LA	Latin	SR	Serbian
CA	Catalan	LN	Lingala	SS	Siswati
CO	Corsican	LO	Laothian	ST	Sesotho
CS	Czech	LT	Lithuanian	SU	Sundanese
CY	Welsh	LV	Latvian, Lettish	SW	Swahili
DZ	Bhutani	MG	Malagasy	TA	Tamil
EL	Greek	MI	Maori	TE	Telugu
EO	Esperanto	MK	Macedonian	TG	Tajik
ET	Estonian	ML	Malayalam	TH	Thai
EU	Basque	MN	Mongolian	TI	Tigrinya
FA	Persian	MO	Moldavian	TK	Turkmen
FJ	Fiji	MR	Marathi	TL	Tagalog
FO	Faroese	MS	Malay (MAY)	TN	Setswana
FY	Frisian	MT	Maltese	TO	Tonga
GA	Irish	MY	Burmese	TR	Turkish
GD	Scots Gaelic	NA	Nauru	TS	Tsonga
GL	Galician	NE	Nepali	TT	Tatar
GN	Guarani	OC	Occitan	TW	Twì
GU	Gujarati	OM	(Afan) Oromo	UK	Ukrainian
HA	Hausa	OR	Oriya	UR	Urdu
HI	Hindi	PA	Panjabi	UZ	Uzbek
HR	Croatian	PL	Polish	VI	Vietnamese
HU	Hungarian	PS	Pashto, Pushto	VO	Volapuk
HY	Armenian	PT	Portuguese	WO	Wolof
IA	Interlingua	QU	Quechua	XH	Xhosa
IE	Interlingue	RM	Rhaeto-Romance	YO	Yoruba
				ZU	Zulu

TV Station And ID List

The "ID" abbreviation is what is shown on-screen in lieu of the station name. The "ID" abbreviation is listed in the Confirmation screen and is displayed on the TV screen when the unit is tuned to a different station.

ID*	STATION NAME
1000	TV1000
3SAT	3SAT
9LIV	9LIVE
AB3	AB3
ADLT	ADULT
ANIM	ANIMAL PLANET
ANT3	ANTENA3
ARD	ARD
ARTE	ARTE
ATV	MAGYAR ATV
B1	BERLIN 1
BBC	BBC GROUP
BBC1	BBC1
BBC2	BBC2
BBCW	BBC WORLD
BIO+	TV BIO+
BLOO	BLOOMBERG
BR3	BAYERN3
C+	CANAL PLUS
C1	PORTUGUSES
C9	VALENCIA
CAN5	CANALE5
CANV	KETNET CANVAS
CANZ	KANAAL Z
CH4	CHANNEL4
CH5	CHANNEL5
CHLD	CHILD
CINE	CINEMA
CLUB	TELECLUB
CMT	CMT
CNN	CNN
CSUR	ANDALUCIA
CT1	CT 1
CT2	CT 2
DISC	DISCOVERY
DK1	DENMARK1
DK2	DENMARK2
DK4	DENMARK4
DR1	DR TV
DR2	DR2
DSF	DSF
DUNA	DUNA TV
ETB1	ETB1
ETB2	ETB2
ETV	ETV
EUNW	EURO NEWS
EURO	EURONEWS
EUSP	EUROSPORTS
FEMM	FEMMAN
FILM	FILM
FNET	FILMNET
FR2	France2
FR3	France3
FR5	France5
GALA	GALAVISION
HBO	HBO
HR3	HESSEN3
HSEU	H.S.EURO
INFO	INFO-KANAL
ITA1	ITALIA1
ITA7	ITALIA7
ITV1	ITV

ID*	STATION NAME
JIM	JIM TV
JSTV	JSTV
KA2	KA2
KAB1	KABEL1
KAN2	KANAL2
KAN5	KANAL5
KBH	KBH.KANAL
KIKA	KINDER.KANAL
LA7	LA7
LIB	LIBERTY TV
LOCA	LOCAL
M6	M6
MBC	MBR
MCM	MCM
MDR	MDR
MOVE	MOVIE
MTV	MTV
MTV1	MTV1
MTV2	MTV2
MTV3	MTV3
NGEO	NATIONAL.G
N24	NEWS24
N3	NORD3
N-TV	N-TV
NBC	NBC SUPER
NDR	NDR
NED1	NED1
NED2	NED2
NED3	NED3
NET5	NETWORK5
NEWS	
NICK	NICKELODEON
NOVA	NOVA
NRK1	NRK
NRK2	NRK2
ODE	ODEON
ORF1	ORF1
ORF2	ORF2
PHOE	PHOENIX
POLS	POL SAT
PREM	PREMIERE
PRIM	PRIMA TV
PRO7	PRO7
RAI1	RAI1
RAI2	RAI2
RAI3	RAI3
RET4	RETE4
RTB1	TELE21
RTB2	RTBF1 or 2
RTL	RTL
RTL2	RTL2
RTL4	RTL4
RTL5	RTL5
RTL7	RTL7
RTLK	RTLK
RTP	RTP
RTV4	RTV4
SAT1	SAT1
SBS6	SBS
SERV	Service
SF1	SF1
SF2	SF2

ID*	STATION NAME
SHOW	SHOW
SIC	SOCIEDADE
SKY	SKY CHANNEL
SKYN	SKY NEWS
SPEK	SPEKTRUM
SPRT	SPORT
SRTL	SUPER RTL
STAR	STAR-TV
SVT1	SVT1
SVT2	SVT2
SV24	NEWS
SWR	SUEDWEST3
TCC	TCC
TCM	TCM
TELE	TELE
TELE5	TELE5
TF1	TF1
TM	TV DE MADRID
TMC	TELEMONTECARLO
TMF	TMF
TNT	TNT INT
TRT	TRT INT
TSI1	TSI
TSI2	TSI2
TSR1	TSR
TSR2	TSR2
TV1	BRTN TV1
TV2	TV2
TV2Z	TV2 ZULU
TV3	TV3
TV3+	TV3 PLUS
TV4	TV4
TV5	TV5
TV6	TV6
TV8	TV8
TVE1	TVE1
TVE2	TVE2
TVG	TV GALICIA
TVI	TV INDEPENDENT
TVN	TV NORGE
TV24	TVN24
TVP1	TVP1
TVP2	TVP2
TV P	TV POLONIA
V8	V8
VCR	VIDEO
VH-1	VH-1
VIT	VITAYA
VIVA	VIVA
VIV2	VIVA2
VMTV	VIDEO MUSIC
VOX	VOX
VSAT	VIASAT3
VT4	VT4
VTM	VTM
WDR3	West3
WRLD	WORLD
YLE1	YLE1
YLE2	YLE2
YORN	YORIN
ZDF	ZDF
ZTV	ZTV

A	
A-B Repeat Playback	56
Accidental erasure prevention	63
Adjusting The Picture Quality	57
Angle Selection	49
Audio Channel Selection	50
Audio Language/Sound Selection	50
Auto Channel Set	17
Automatic Satellite Programme Recording	36
C	
Check, Cancel And Change Programmes	34
Copy-once contents	94
CPRM	94
D	
Delete Title	67
Disc menu	47
Disc Resume	80
Discs For Playback Only	6
E	
Elapsed Recording Time And Disc Remaining Time Indication	61
Elapsed Recording Time Indication	63
F	
File Structure Of Discs	7
Free Rate Function	62
G	
Guide Program Number	83
H	
High-Speed Search	47, 59
I	
Index Search	59
Instant Timer Recording (ITR)	61, 63
Interlaced scan	80
J	
Just Clock	88
L	
Language Code List	96
Letter Box	21
Live Memory	51
M	
Manual Channel Set	85
Manual Tracking	60
Marking Positions To Play Back Again Later	49
Menu/Audio/Subtitle Language Set	20
N	
Next Function Memory	60
O	
On-Disc Timer Programming	32
One Touch Replay Function	54
One-Touch Expert Dubbing	37
On-screen Bar	55
On-screen Language Set	20

P	
Pan&Scan	21
Play List	68
Playback Control (PBC) Function	50
Programme Playback	58, 72
Progressive scan	80
Q	
Quick Rewind A Little	59
R	
Random Playback	58
Recordable/Playable Discs	6
Recording Medium And Format	7
Recording Mode	27, 28
Recording Resume Function	27, 28
Region Number	7
Register Disc	71
Repeat Playback	56, 60
Resume Function	48
S	
Select The Switching Interval Of The Slide Show	58
Setting The Progressive Mode	57
Skip Search	48, 59
Slow Motion	48, 59
Soundtrack Selection	60
Still Picture/Frame-By-Frame Playback	48, 59
Subtitle Selection	49
T	
Tape Remaining Time	64
Time Search	57
Top menu	47
U	
Unplayable Discs	7
Usable cassettes	25
V	
VHS Progressive Scan	60
Video mode	7, 89
VPS/PDC Recording	30
VR mode	7, 89
W	
When Programmes Overlap Each Other	35

EN

**DR-MV5SE
DR-MV5BE**

JVC